

COMPUTER BOOSTER FOR RRB PO & CLERK MAINS

Inside Story

Important Inventions & Discoveries	1
Generation of Computers	2
Computer Memory	2
Types of Computer	5
Operating System	6
Computer Network	7
➤ Servers	8
➤ Network Devices	11
➤ OSI Model	11
➤ IP Address	13
➤ Some Important Networking Terminology	13
Number System	16
M.S. Word/Excel Shortcuts	17
Single Linear Questions	18
Important Abbreviations	25
Most Expected 400 MCQ	26



Important Inventions & Founders

- ❖ Father of Computer– **Charles Babbage**
- ❖ First Modern Computer in the World- **ENIAC**
- ❖ Inventor of Punch Cards in Computer – **Hollerith**
- ❖ Computer Graphics was developed by – **William Fetter**
- ❖ ARPANET was developed by – **DARPA**
- ❖ Compiler was developed by – **Dr. Grace Murray Hopper**
- ❖ Father of Computer Animations- **John Whitney**
- ❖ Keyboard was invented by- **Christopher Latham Sholes**
- ❖ Laptop Computer was invented by – **Adam Osborne**
- ❖ First GUI Computer Game was invented by- **A.S. Douglas**
- ❖ Computer BIOS was invented by – **Gary Kildall**
- ❖ Inventors of Computer Chip– **Jack Kilby & Robert Noyce**
- ❖ Father of Computer Hard Disk- **Reynold Johnson**
- ❖ Inventor of First Data Base – **Dr. Edgar Frank Codd**
- ❖ Inventor of Computer Scanner – **Ray Kurzweil**
- ❖ Inventor of Computer Speakers- **Abinawan Puracchidas**
- ❖ Inventor of MS-DOS Operating Systems- **Microsoft**
- ❖ Founder of Apple Computers – **Steve Jobs**
- ❖ Founder of Artificial Intelligence – **John McCarthy**
- ❖ Founder of Bluetooth – **Ericsson**
- ❖ Father of C Language – **Dennis Ritchie**
- ❖ Father of C++ language – **Bjarne Stroustrup**
- ❖ Founder of Email – **Shiva Ayyadurai**
- ❖ Founder of Google – **Larry Page and Sergey Brin**
- ❖ Founder of Internet – **Vint Cerf**
- ❖ Father of Java - **James Gosling**
- ❖ Founder of Linux – **Linus Torvalds**
- ❖ Founder of Microsoft – **Bill Gates and Paul Allen**
- ❖ Founder of Mobile Phones – **Martin Cooper**
- ❖ Founder of Mouse – **Douglas Engelbart**
- ❖ Founder of Php – **Rasmus Lerdorf**
- ❖ Founder of USB – **Ajay V.Bhatt**
- ❖ Founder of WWW – **Tim Berners-Lee**
- ❖ Founder of Yahoo – **Jurry Yang and David Filo**
- ❖ First Commercial Computer – **UNIVAC**
- ❖ ENIAC and UNIVAC was developed by – **John Mauchly and J. Presper Eckert**



Generation of Computers

	1 st	2 nd	3 rd	4 th	5 th
Period	1940 – 1956	1956 – 1963	1964 – 1971	1972 – 2010	2010-till date
Components	Vacuum Tubes	Transistor	Integrated Circuits – ICs	Microprocessor, Large Scale ICs	Silicon Chips, ULSI, AI
Computer	EDVAC, ENIAC, EDSAC UNIVAC	IBM-1401	IBM-370	PDP 11	NoteBook UltraBook....

There are two basic components of computer, **Hardware and Software**.

1. Hardware- physical components of the computer system are called as hardware. For example- **Mother Board, Input Devices, Output Device, Storage Devices**

Input Devices are used to enter the input i.e. the data and instructions into the computer's main memory. Examples- keyboard, Mouse, scanner, BCR, OMR, OCR, Light Pen, Joysticks, Etc..

Output Device are used to produce data and information generated by computer .for example- Monitor, Printer, speaker, Plotter, Etc.

2. Software- Software is a sequence of instructions designed to direct the computer to perform certain functions. It is generally classified into three categories:

(i) **System Software-** This type of software is required to use the computer efficiently and conveniently. For example- Operating System, Drivers etc.

(ii) **Application Software-** This software is designed to do certain tasks for an organization. For example Ms.Office, Payroll system to calculate salaries of the employees, etc.

(iii) **Utility Software-** It is designed to analyze, configure and maintain a computer. For example- Antivirus, etc.



Computer Memory

Computer memory is the storage space in computer where data is to be processed and instructions required for processing are stored.

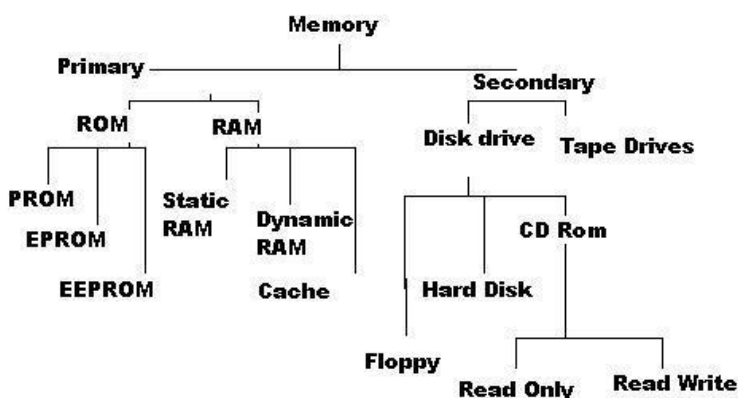

1. Primary Memory

2. Secondary Memory

Primary Memory (Main Memory)- Primary memory holds only those data and instructions on which computer is currently working. It has limited capacity and data is lost when power is switched off. It is generally made up of semiconductor device. These memories are not as fast as registers. The data and instruction required to be processed reside in main memory. It is divided into two subcategories RAM and ROM.

Characteristics of Main Memory-

- ❖ These are semiconductor memories, It is also known as main memory.
- ❖ Usually volatile memory.
- ❖ Data is lost in case power is switched off.
- ❖ It is working memory of the computer.
- ❖ Faster than secondary memories.

Secondary Memory(Auxiliary Memory)- This type of memory is also known as external memory or non-volatile. It is slower than main memory. These are used for storing data/Information permanently. CPU directly does not access these memories instead they are accessed via input-output routines. Contents of secondary memories are first transferred to main memory, and then CPU can access it. For example: disk, CD-ROM, DVD etC.

Characteristic of Secondary Memory

- ❖ These are magnetic and optical memories It is known as backup memory.
- ❖ It is non-volatile memory.
- ❖ Data is permanently stored even if power is switched off.
- ❖ It is used for storage of data in a computer.
- ❖ Computer may run without secondary memory.
Slower than primary memories.

RAM (Random Access Memory) is the internal memory of the CPU for storing data, program, and program result. It is a read/write memory which stores data until the machine is working. As soon as the machine is switched off, data is erased. RAM is volatile, i.e. data stored in it is lost when we switch off the computer or if there is a power failure. Hence, a backup Uninterruptible Power System (UPS) is often used with computers.

RAM is of two types –

1. Static RAM (SRAM)

2. Dynamic RAM (DRAM)

Static RAM (SRAM)

The word **static** indicates that the memory retains its contents as long as power is being supplied. However, data is lost when the power gets down due to volatile nature. SRAM chips use a matrix of 6-transistors and no capacitors. Transistors do not require power to prevent leakage, so SRAM need not be refreshed on a regular basis. There is extra space in the matrix, hence SRAM uses more chips than DRAM for the same amount of storage space, making the manufacturing costs higher. SRAM is thus used as cache memory and has very fast access.

Dynamic RAM (DRAM)

DRAM, unlike SRAM, must be continually **refreshed** in order to maintain the data. This is done by placing the memory on a refresh circuit that rewrites the data several hundred times per second. DRAM is used for most system memory as it is cheap and small. All DRAMs are made up of memory cells, which are composed of one capacitor and one transistor.

Cache Memory

Cache memory is a very high speed semiconductor memory which can speed up the CPU. It acts as a buffer between the CPU and the main memory. It is used to hold those parts of data and program which are most frequently used by the CPU. The parts of data and programs are transferred from the disk to cache memory by the operating system, from where the CPU can access them.

ROM (Read Only Memory)

ROM stands for **Read Only Memory**. The memory from which we can only read but cannot write on it. This type of memory is non-volatile. The information is stored permanently in such memories during manufacture. A ROM stores such instructions that are required to start a computer. This operation is referred to as **bootstrap**. ROM chips are not only used in the computer but also in other electronic items like washing machine and microwave oven.

MROM (Masked ROM)

The very first ROMs were hard-wired devices that contained a pre-programmed set of data or instructions. These kind of ROMs are known as masked ROMs, which are inexpensive.

PROM (Programmable Read Only Memory)

PROM is read-only memory that can be modified only once by a user. The user buys a blank PROM and enters the desired contents using a PROM program. Inside the PROM chip, there are small fuses which are burnt open during programming. It can be programmed only once and is not erasable.

EPROM (Erasable and Programmable Read Only Memory)

EPROM can be erased by exposing it to ultra-violet light for a duration of up to 40 minutes. Usually, an EPROM eraser achieves this function. During programming, an electrical charge is trapped in an insulated gate region. The charge is retained for more than 10 years because the charge has no leakage path. For erasing this charge, ultra-violet light is passed through a quartz crystal window (lid). This exposure to ultra-violet light dissipates the charge. During normal use, the quartz lid is sealed with a sticker.

EEPROM (Electrically Erasable and Programmable Read Only Memory)

EEPROM is programmed and erased electrically. It can be erased and reprogrammed about ten thousand times. Both erasing and programming take about 4 to 10 ms (millisecond). In EEPROM, any location can be selectively erased and programmed. EEPROMs can be erased one byte at a time, rather than erasing the entire chip. Hence, the process of reprogramming is flexible but slow.



Units of Computer Memory

Bit	0,1
1 Nibble	4 Bits
1 Byte or Character	8 Bits
1 KB (Kilo Byte)	1024 Bytes
1 MB (Mega Byte)	1024 KB
1 GB (Giga Byte)	1024 MB
1 TB (Tera Byte)	1024 GB
1 PB (Peta Byte)	1024 TB
1EB (Exa Byte)	1024 PB
1ZB (Zetta Byte)	1024 EB
1YB (Yotta Byte)	1024 ZB



Types of Computer

1. PC
2. Laptop
3. Minicomputer
4. Microcomputer
5. Mainframe Computer
6. Palmtop
7. Super computer



Super Computer

A **supercomputer** is a computer with great speed and memory. This kind of computer can do jobs faster than any other computer of its generation. They are usually thousands of times faster than ordinary personal computers made at that time. The first Atlas was officially commissioned on **7 December 1962**, nearly three years after the Cray **CDC 6600** supercomputer was introduced, as one of the world's first supercomputers.

Seymour Cray is called as father of super computer.

Top 5 Super computer in the world in year-2017

Rank	Name	R Maks (Tflop)	Site
1	Sunway Taihulight	93.7Petaflops	National Super Computer Center in Wuxi, China
2	Tianhe-2	33.8 petaflops	National Super Computer Center in Guangzhou, China
3	Piz Daint	19.0 petaflops	Swiss national supercomputing, Switzerland
4	Titan	17.6 petaflops	Oak Ridge National Laboratory, United States
5	Sequoia	17.2 petaflops	Lawrence Livermore National Laboratory, United States

Jun-2017 India has 4 system in top 500 super computer List -

NAME	RANK (in world)
Sahasrat(CRAY-XC 40)	165
Aadita	261
TIFR	356
HP Apollo	392



Operating System

An **Operating System**, or OS, is a software program that enables the computer hardware to communicate and operate with the computer software. Without a computer Operating System, a computer would be useless.



Basic functions of an operating system-

- ❖ Operating system controls and coordinates the use of the hardware among the various applications programs for various uses.
- ❖ **Operating system** acts as **resource allocator** and manager. Since there are many possibly conflicting requests for resources the operating system must decide which requests are allocated resources to operating the computer system efficiently and fairly?
- ❖ Operating system is control program which controls the user programs to prevent errors and improper use of the computer. It is especially concerned with the operation and control of I/O devices.
- ❖ **Multiprogramming** – In multiprogramming more than one program reside in the main memory. When one job is unable to execute because of I/O operation to complete, it switches to other program and allow that program to run The main motive of multiprogramming is to utilize the CPU efficiently.
- ❖ **Multitasking**-In multitasking operating system more than one program is assigned to the CPU or switches between the programs occurs so fast that it seems like more than one program is running. The main motive of multitasking is to utilize the CPU efficiently and reduce the response time.

- ❖ **Multiprocessing**-In multiprocessing operating system a task is divided between more than one processor (CPU) so that parallelism can be achieved.
- ❖ **Multithreading** -Sometime a program need to do multiple task at the same time. It is an extension of multiprogramming. In multithreading the program is divided into multiple task .

Throughput, Turnaround time, waiting time and Response time :-

- ❖ **Throughput** – number of processes that complete their execution per time unit.
- ❖ **Turnaround time** – amount of time to execute a particular process.
- ❖ **Waiting time** – amount of time a process has been waiting in the ready queue.
- ❖ **Response time** – amount of time it takes from when a request was submitted until the first response is produced, not output (for time-sharing environment).

Hard and Soft real-time systems:-

- ❖ A **hard real** time system guarantees that critical tasks complete on time. This goal requires that all delays in the system be bounded from the retrieval of the stored data to the time that it takes the operating system to finish any request made of it.
- ❖ A **soft real** time system where a critical real-time task gets priority over other tasks and retains that priority until it completes. As in hard real time systems kernel delays need to be bounded



Windows

- ❖ In 1983 **Bill Gates** announces Microsoft Window November 10, 1983,
- ❖ Microsoft **Windows 1.01** is introduced in **November 20,1985** and initially sold for \$100.00
- ❖ Microsoft **Windows 1.03** is introduced in **August 1986**.
- ❖ Microsoft **Windows NT(New Technology)** is introduced in **27 July 1993**.
- ❖ Microsoft **Windows ME(Millennium)** is introduced in **2000**.
- ❖ Microsoft **Windows XP(eXPerience)** is introduced in **25 October 2001**.



Networking

A **computer network** is a system in which multiple computers are connected to each other to share information and resources.

Characteristics of a Network :

A network is a group of systems that are connected to allow sharing of resources—such as files or printers—or sharing of services-such as an Internet connection .There are two aspects of setting up a network: the hardware used to connect the systems together and the software installed on the computers to allow them to communicate.

Basic Communication Model :

Communication model is used to exchange data between two parties. For example communication between a computer, server and telephone (through modem).

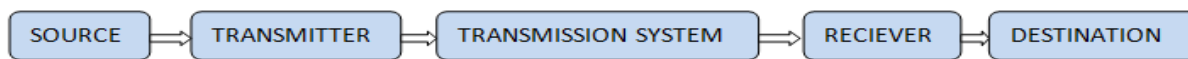

- ❖ **Source-** Data to be transmitted is generated by this device, example: telephones, personal computers etc.
- ❖ **Transmitter-** The data generated by the source system are not directly transmitted in the form they are generated. The transmitter transforms and encodes the information in such a form to produce electromagnetic waves or signals.
- ❖ **Transmission System-** A transmission system can be a single transmission line or a complex network connecting source and destination.
- ❖ **Receiver-** Receiver accepts the signal from the transmission system and converts it to a form which is easily managed by the destination device.
- ❖ **Destination-** Destination receives the incoming data from the receiver.

Network Topology: Topology is the geometric arrangement of a computer system. Each computer system in a topology is known as a node. Network topology is determined only by the configuration of connections between nodes.

- ❖ **Bus Topology:** A bus topology is such that there is a single line to which all nodes are connected and the nodes connect only to this bus.
- ❖ **Mesh Topology:** This type of network topology contains at least two nodes with two or more paths between them.
- ❖ **Ring Topology:** In this network topology, every node has exactly two branches connected to it. The ring is broken and cannot work if one of the nodes on the ring fails.
- ❖ **Star Topology:** In this network topology, the peripheral nodes are connected to a central node, which rebroadcasts all transmissions received from any peripheral node to all peripheral nodes on the network, including the originating node.
- ❖ **Tree Topology:** This is a network topology in which nodes' are arranged as a tree. The function of the central node in this topology may be distributed.



Servers

The server is a special computer that contains more disk space and memory than are found on client workstations. The server has special software installed that allows it to function as a server. This special software can provide file and print services (to allow sharing of files and printers), provide web pages to clients, or provide e-mail functionality to the company.

Workstations - The workstation also is known as a client, which is just a basic computer running a client operating system such as Windows XP or Linux. These users typically store their files on a central server so that they can share the files with other users on the network.

Hosts- The term host refers to any computer or device that is connected to a network and sends or receives information on that network. A host can be a server, a workstation, a printer with its own network card, or a device such as a router. We can summarize by saying that any system or device that is connected to the network is known as a host.

Types of Networks- Organizations of different sizes, structures, and budgets need different types of networks. Networks can be divided into one of two categories: peer-to-peer or server-based networks.

1. Peer-to-Peer Network
2. Server-Based Networks

Peer-to-Peer Network

A peer-to-peer network has no dedicated servers instead; a number of workstations are connected together for the purpose of sharing information or devices. When there is no dedicated server, all workstations are considered equal; any one of them can participate as the client or the server. Peer-to-peer networks are designed to satisfy the networking needs of home networks or of small companies that do not want to spend a lot of money on a dedicated server but still want to have the Capability to share information or devices. For example, A small peer-to-peer network will allow these three computers to share the printer and the customer information with one another .The extra cost of a server was not incurred because the existing client systems were networked together to create the peer-to-peer network. A big disadvantage of peer-to-peer networking is that you can't do your day-today administration in a single place.

Server-Based Networks

Usually after four or five systems have been networked, the need for a dedicated server to store all of the user accounts and data files becomes apparent—this is a server-based network. The advantage of a server-based network is that the data files that will be used by all of the users are stored on the one server. This will help you by giving you a central point to set up permissions on the data files, and it will give you a central point from which to back up all of the data in case data loss should occur. With a server-based network, the network server stores a list of users who may use network resources and usually holds the resources as well. The server in a server-based network may provide a number of different services. The services it will offer to the network usually are decided by the server's role. There are a number of different roles that a server could play on a network:

1. File and print servers
2. Application servers
3. Web servers
4. Directory servers

1. File and print servers-

File and print servers control and share printers and files among clients on the network. File and print servers were the original reason to have a network; a large number of users needed access to the same files, so the files were placed on a server, and all clients were connected to the server when they needed to work with the files.

2. Application servers-

Application servers are servers that run some form of special program on the server. A good example of an application server is a server that runs the company's e-mail server. The e-mail server software is special software that can be run on a server operating system. Another example of software that would run on an application server is a database server product such as Microsoft SQL Server. A database server is a server that holds the company's core business data and typically gives this data to custom applications that run on the workstations. These are some applications that you might find on an application server:

1. Microsoft SQL Server
2. Oracle
3. Microsoft Exchange Server
4. IBM Lotus Domino

3. Web servers-

Web servers are servers that run the Hypertext Transfer Protocol (HTTP) and are designed to publish information on the Internet or the corporate intranet. Web servers are popular in today's businesses because they host web applications (web sites) for the organization. These web applications could be designed for internal use, or they could be used to publish information to the rest of the world on the Internet. Examples of web server software are Microsoft's Internet Information Services that runs on Windows or Apache web server software that runs on UNIX/Linux, Novell NetWare, and Windows.

4. Directory servers-

Directory servers hold a list of the user accounts that are allowed to log on to the network. This list of user accounts is stored in a database (known as the directory database) and can store information about these user accounts such as address, city, phone number, and fax number. A directory service is designed to be a central database that can be used to store everything about such objects as users and printers.

Network Media and Connectors:-

Cabling is the medium for the transmission of data between hosts on the LANs. LANs can be connected together using a variety of cable types, such as unshielded twisted-pair, coax, or fiber. Each cable type has its own advantages and disadvantages, which you will examine in this section. There are three primary types of cable media that can be used to connect systems to a network—coaxial cable, twisted-pair cable, and fiber-optic cable. Transmission rates that can be supported on each of these physical media are measured in millions of bits per second, or megabits per second (Mbps).

Coaxial Cable:-

Coaxial, or coax, cable looks like the cable used to bring the cable TV signal to your television. One strand (a solid-core copper wire) runs down the middle of the cable. There are two types of coax cabling: thinnet and thicknet. The two differ in thickness and maximum cable distance that the signal can travel.

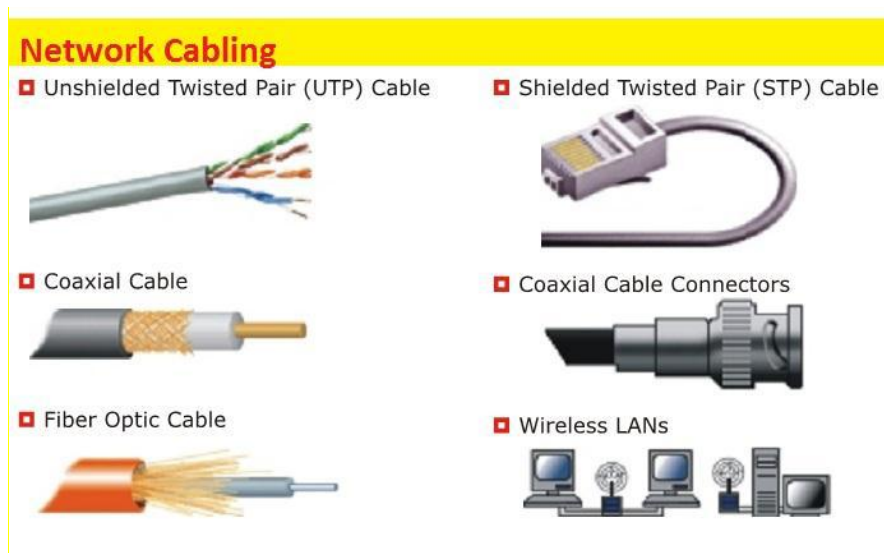
**Twisted-Pair Cable:-**

Coaxial cable is not as popular today as it was a few years ago; today the popularity contest has been dominated by twisted-pair cabling. Twisted-pair cabling gets its name by having four pairs of wires that are twisted to help reduce crosstalk or interference from outside electrical devices. (Crosstalk is interference from adjacent wires.) There are two forms of twisted-pair cabling—unshielded twisted-pair (UTP) and shielded twisted-pair (STP).

Fiber-Optic Cable:-

The third type of cabling that we want to discuss is fiber-optic cabling. Fiber-optic cabling is unlike coax and twisted-pair, because both of those types have a copper wire that carries the electrical signal. Fiber-optic cables use optical fibers that carry digital data signals in the form of modulated pulses of light. An optical fiber consists of an extremely thin cylinder of glass, called the core, surrounded by a concentric layer of glass, known as the cladding. There are two fibers per cable—one to transmit and one to receive. The core also can be an optical-quality clear plastic, and the cladding can be made up of gel that reflects signals back into the fiber to reduce signal loss. There are two types of fiber-optic cables: single-mode fiber (SMF) and multimode fiber (MMF).

- 1. Single-mode fiber** Uses a single ray of light, known as a mode, to carry the transmission over long distances.
- 2. Multimode fiber** Uses multiple rays of light (modes) simultaneously, with each ray of light running at a different reflection angle to carry the transmission over short distances

Cable	Max Distance	Transfer Rate	Connector Used
Thinnet	185 m	10 Mbps	BNC
Thicknet	500 m	10 Mbps	AUI
CAT 3 (UTP)	100 m	10 Mbps	RJ-45
CAT 5 (UTP)	100 m	100 Mbps	RJ-45
CAT 5e	100 m	1 Gbps	RJ-45
CAT 6	100 m	10 Gbps	RJ-45
Fiber	2 km	1+ Gbps	SC, ST



Network Devices

Network devices are components used to connect computers or other electronic devices together so that they can share files or resources like printers or fax machines. Devices used to setup a Local Area Network (LAN) are the most common types of network devices used by the public. A LAN requires a **hub, router, cabling** or **radio technology, network cards**, and if online access is desired, a high-speed **modem**. This is much less complicated than it might sound to someone new to networking.

- ❖ **Hub**- Broadcasts data from one port to all other ports in the network.
- ❖ **Repeater**- Regenerates the input data which is subjected to attenuation.
- ❖ **Switch**- Intelligent device which sends data to particular port.
- ❖ **Bridge**-Same function as switch but much more primitive and has lesser ports.
- ❖ **Router**-Connects all computers from a LAN to internet using same IP.
- ❖ **IEEE 802.11**- WiFi standard- 802.11 b has speed of 11 Mbps, 802.11 g has a speed of 54 Mbps and 802.11 N uses multiple wireless signals and antennas and has speeds of over 100Mbps.
- ❖ **Gateway**-Needed when 2 different network technologies are being used. Acts as translator.
- ❖ **Connecting Cables**- RJ-11(Telephone Cable), RJ 45 (LAN Cable), Twisted pair cables (used in connecting 2 computers), Null Modem Cable (RS232) , Optial Fibre Cable(Gigabit Ethernet).
- ❖ **ARPANET**- **Advanced Research Projects Agency Network, ARPANET** or **ARPAnet** began development in 1966 by the United States ARPA. ARPANET was a Wide Area Network linking many Universities and research centers, was first to use packet switching, and was the beginning of what we consider the Internet today. Some of the reasons for creating ARPANET include making it easier for people to access computers, to improve computer equipment, and to have a more effective communication method for the military.



OSI Model

OSI (Open Systems Interconnection) is reference model for how messages should be transmitted between any two points in a telecommunication network. A reference model is a framework for understanding relationships. The purpose of the OSI reference model is to guide vendors and developers so that the digital communication products and software programs they create will interoperate. The OSI reference model defines seven layers of functions that take place at each end of a communication.

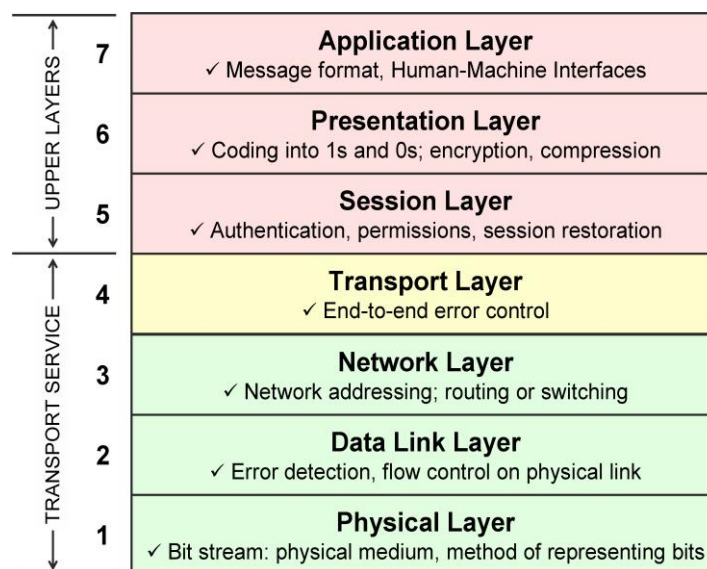
Layers of Osi -

Layer 7: The application layer - This is the layer at which communication partners are identified, quality of service (QoS) is identified, user authentication and privacy are considered, and any constraints on data syntax are identified. (This layer is not the application itself, although some applications may perform application layer functions.)

Layer 6: The presentation layer - This is a layer, usually part of an operating system (OS), that converts incoming and outgoing data from one presentation format to another (for example, from a text stream into a popup window with the newly-arrived text).

Layer 5: The session layer - This layer sets up, coordinates, and terminates conversations, exchanges, and dialogs between the applications at each end. It deals with session and connection coordination.

Layer 4: The transport layer - This layer manages the end-to-end control (for example, determining whether all packets have arrived) and error-checking. It ensures complete data transfer.

Layer 3: The network layer - This layer handles the routing of the data (sending it in the right direction to the right destination on outgoing transmissions and receiving incoming transmissions at the packet level). The network layer does routing and forwarding.

Layer 2: The data-link layer - This layer provides synchronization for the physical level and does bit-stuffing for strings of 1's in excess of 5. It furnishes transmission protocol knowledge and management. This layer has two sub layers, the Logical Link Control Layer and the Media Access Control Layer.

Layer 1: The physical layer - This layer conveys the bit stream through the network at the electrical and mechanical level. It provides the hardware means of sending and receiving data on a carrier network.



IP Addresses

Every machine on a network has a unique identifier. Most networks today, including all computers on the Internet, use the TCP/IP protocol as the standard for how to communicate on the network. In the TCP/IP protocol, **the unique identifier for a computer is called its IP address.**

There are two standards for IP addresses:-

1) IP Version 4 (IPv4)

2) IP Version 6 (IPv6).

All computers with IP addresses have an IPv4 address, and many are starting to use the new IPv6 address system as well. Here's what these two address types mean:-

IPv4 uses **32 binary** bits to create a single unique address on the network. An IPv4 address is expressed by four numbers separated by dots. Each number is the decimal (base-10) representation for an eight-digit binary (base-2) number, also called an octet. For example: **216.27.61.137**.

Class A - 0.0.0.0 - 127.255.255.255

Class B - 128.0.0.0 - 191.255.255.255

Class C - 192.0.0.0 - 223.255.255.255

Class D - 224.0.0.0 - 239.255.255.255

Class E - 240.0.0.0 - 247.255.255.255

IPv6 uses **128 binary** bits to create a single unique address on the network. An IPv6 address is expressed by eight groups of hexadecimal (base-16) numbers separated by colons, as in **2001:cdba:0000:0000:0000:3257:9652**. Groups of numbers that contain all zeros are often omitted to save space, leaving a colon separator to mark the gap (as in 2001:cdba::3257:9652).



Some Important Networking Terminology

- ❖ **MAC address** -: The address for a device as it is identified at the Media Access Control (MAC) layer in the network architecture. MAC address is usually stored in ROM on the network adapter card and is unique.
- ❖ **Bandwidth** -: Every line has an upper limit and a lower limit on the frequency of signals it can carry. This limited range is called the bandwidth.
- ❖ **Bookmark** - When referring to the Internet or a browser, a bookmark or electronic bookmark is a method of saving a web page's address. For example, with most browsers pressing Ctrl + D will bookmark the page you are viewing.
- ❖ **Bounce** -A description of what occurs when an e-mail message returns back to the sender as undeliverable. Some e-mail programs also have a **bounce** or **bounce back** feature built into them, which allows the user to bounce messages back to the sender causing the e-mail address to appear invalid.
- ❖ **Buffer**-When referring to memory, a buffer is a temporary storage in memory that stores information while processing other information.
- ❖ **Cloud computing** -A term used to describe services over a network by a collection of servers. These computers or cloud of computers enable the users visiting to have access to much faster computers or servers, be able to access programs and services from anywhere with Internet access often without having to install other software, and get access to the services from any device capable of reaching the network or Internet
- ❖ **Cyber Law**- Cyber law is the part of the overall legal system that deals with the Internet, cyberspace, and their respective legal issues. Cyber law covers a fairly broad area, encompassing several subtopics including freedom of expression, access to and usage of the Internet, and online privacy. Generically, cyber law has been referred to as the Law of the Internet.

- ❖ **DNS-:** Domain Name System or Domain Name Service, a DNS is an Internet or other network server that helps to point domain names or the hostname to their associated IP address that was introduced by **Paul Mockapetris** and **Jon Postel** in 1984. If a domain name is not found within the local database, the server may query other domain servers to obtain the address of a domain name. For example, when a user is accessing the Computer Hope domain a user would enter the easy to remember domain: computerhope.com. When entered that domain name is looked up on a Domain Name System to translate that name into an IP address that can be better understood by computer, E.g. 69.72.169.241. Using that IP address the computers can then find the computer containing the Computer Hope web page and forward that information to your computer.
- ❖ **E-learning- :** E-learning Stands for electronic learning, E-learning (or eLearning) is a term used to describe the process of acquiring knowledge via the use of a computer and the Internet, intranet, or extranet, using various types of media. The multimedia may include streaming video, audio recordings, videoconferencing using a webcam, and even virtual worlds, such as Second Life. It is commonly self-paced but can be led by an instructor as well.
- ❖ **Phishing-:** Pronounced like fishing, phishing is a term used to describe a malicious individual or group of individuals scamming users by sending e-mails or creating web pages that are designed to collect an individual's online bank, credit card, or other login information. Because these e-mails and web pages look like legitimate companies users trust them and enter their personal information.



- ❖ **Pop-up-:** Term used to describe a Window that appears on top of all other Windows. This term became a well-known term with the advent of intrusive and non-intrusive Internet pop-up ads. These ads became increasingly annoying as this form of advertising started to become more popular with many web pages.
- ❖ **Search engine-:** A search engine is a software program or script available through the Internet that searches documents and files for keywords and returns the results of any files containing those keywords. Today, there are thousands of different search engines available on the Internet, each with their own abilities and features. The first search engine ever developed is considered Archie, which was used to search for FTP files and the first text-based search engine is considered Veronica. Today, the most popular and well known search engine is **Google**.



- ❖ **Server side scripting-:** Server-side scripting is a method of designing Websites so that the process or user request is run on the originating server. These scripts provide an interface to the user and are used to limit access to proprietary data. These scripts also work with reusability and allow the webmaster to control access to the source code of the script to limit any attempts at reverse engineering; additionally some of the coding used in these scripts may even be valuable or proprietary.
- ❖ **ASP- :** Active Server Pages, an ASP page is a dynamically created web page that commonly ends with a .ASP extension that utilizes ActiveX scripting, usually VBScript or JScript code. The .aspx extension is used for Web pages that use Microsoft's ASP.NET. These pages are called "Web Forms", and can contain (X) HTML code as well as ASP.NET code.
- ❖ **Web page-:** A web page or webpage is a document commonly written in Hyper Text Markup Language (HTML) that is accessible through the Internet or other network using a browser. A web page is accessed by entering a URL addresses and may contain text, graphics, and hyperlinks to other web pages and files.
- ❖ **WWW-:** Short for World Wide Web, WWW sometimes also abbreviated as W3 or Web is a graphical interface for the Internet that was first introduced to the public on August 6, 1991 by Tim Berners-Lee. The World Wide Web consists of billions of pages linked to each other that contain text, graphics, multimedia files, and other interactive software. Unlike other services available through the Internet, the World Wide Web provides a rich medium and helps brings all people together. The first web site was built at CERN by **Tim Berners-Lee** and put online August 6, 1991.
- ❖ **Firewall-:** A firewall is a software utility or hardware device that limits outside network access to a computer or local network by blocking or restricting network ports. Firewalls are a great step for helping prevent un-authorized access to a company or home network. The picture is an example of a hardware firewall, the ZyXEL ZyWALL a Unified Security Gateway with a Firewall and other security features. In addition to hardware firewalls like that shown above, basic hardware firewalls are also commonly found in most network routers and can be configured and setup through the router setup. Software firewalls are designed to protect the computer they are installed onto by blocking any unrestricted programs from sending and receiving information from the network or Internet. A good example of a software Firewall is the Windows Firewall that is included with Microsoft Windows.
- ❖ **NIC-:** Short for Network Interface Card, a NIC is also commonly referred to as an Ethernet card and network adapter and is an expansion card that enables a computer to connect to a network such as a home network or the Internet using an Ethernet cable with a RJ-45 connector. The picture is an example of a SMC EZ Card 10/100 PCI network card, a network card commonly found in most desktop computers today that do not already have an onboard network on their motherboard.
- ❖ **Packet switching-:** A method of distributing data over a network first developed by Leonard leinrock between 1959 and 1962 and first widely used on ARPANET. In packet switching, information is broken into small segments of data known as packets and then reassembled when received at the destination. This helps prevent any small information sent after larger information from having to wait until the larger information has been sent. When information is broken into packets, the information size and speed of the line is what determines how fast it takes to send information over a network and not the order in which it was sent.

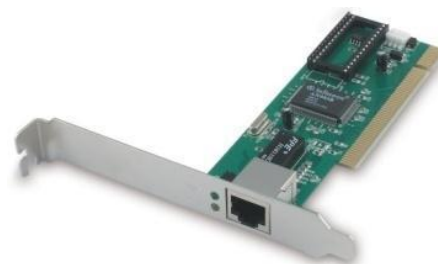
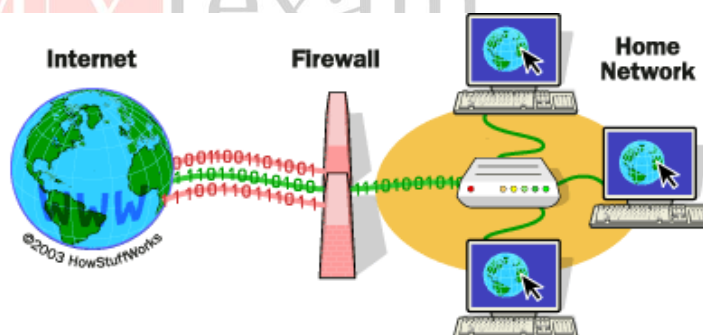

- ❖ **Proxy server-:** A proxy is a computer server or software program that is part of the gateway server or another computer that separates a local network from outside networks. A proxy server will cache all pages accessed through the network allowing users who may want to visit that same page to load it faster and reduce the networks bandwidth. When a page is accessed that is not in the proxy server's cache, the proxy server will access the page using its own IP address, cache the page, and forward it to the user accessing that page.
- ❖ **Spam-:** spam is most often considered to be electronic junk mail or junk newsgroup postings. Some people define spam even more generally as any unsolicited email. However, if a long-lost brother finds your email address and sends you a message, this could hardly be called spam, even though it is unsolicited. Real spam is generally email advertising for some product sent to a mailing list or newsgroup. In addition to wasting people's time with unwanted e-mail, spam also eats up a lot of network bandwidth. Consequently, there are many organizations, as well as individuals, who have taken it upon themselves to fight spam with a variety of techniques. But because the Internet is public, there is really little that can be done to prevent spam, just as it is impossible to prevent junk mail. However, some online services have instituted policies to prevent spammers from spamming their subscribers.



- ❖ **Client-server architecture- :** Technology that separates computers and application software into two categories clients, and servers to better employ available computing resources and share data processing loads. A client computer provides the user interaction-facility (interface) and some or all application processing, while the a server computer might provide high-volume storage capacity, heavy data crunching, and/or high resolution graphics. Typically, several client computers are connected through a network (or networks) to a server which could be a large PC, minicomputer, or a mainframe computer. Every computer connected to a website acts as a client while the website's computer acts as a server. Also called client-server environment.

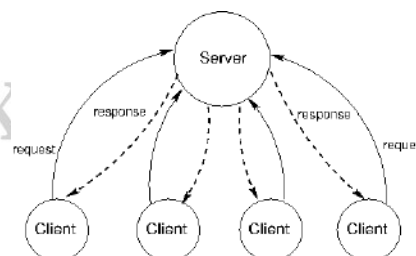

Number System

Number systems are the technique to represent numbers in the computer system architecture, every value that you are saving or getting into/from computer memory has a defined number system. Computer architecture supports following number systems.

- ❖ Binary number system
- ❖ Octal number system
- ❖ Decimal number system
- ❖ Hexadecimal (hex) number system

1) Binary Number System-:

A Binary number system has only two digits that are 0 and 1. Every number represents with 0 and 1 in this number system. The base of binary number system is 2, because it has only two digits.

2) Octal number system:-

Octal number system has only eight (8) digits from 0 to 7. Every number represents with 0,1,2,3,4,5,6 and 7 in this number system. The base of octal number system is 8, because it has only 8 digits.

3) Decimal number system-

Decimal number system has only ten (10) digits from 0 to 9. Every number represents with 0,1,2,3,4,5,6, 7,8 and 9 in this number system. The base of decimal number system is 10, because it has only 10 digits.

4) Hexadecimal number system:-

A Hexadecimal number system has sixteen (16) alphanumeric values from 0 to 9 and A to F. Every number represents with 0,1,2,3,4,5,6, 7,8,9,A,B,C,D,E and F in this number system. The base of hexadecimal number system is 16, because it has 16 alphanumeric values. Here A is 10, B is 11, C is 12, D is 13, E is 14 and F is 15.

Number system	Base	Used digits	Example
Binary	2	0,1	(11110000) ₂
Octal	8	0,1,2,3,4,5,6,7	(257) ₈
Decimal	10	0,1,2,3,4,5,6,7,8,9	(230) ₁₀
Hexadecimal	16	0,1,2,3,4,5,6,7,8,9, A,B,C,D,E,F	(F9) ₁₆



M.S.Word/Excel Shortcuts

M.S.Word/ Excel Shortcuts with CTRL from A-Z Alphabetically :-CTRL + **A** = Select textCTRL + **C** = Copy textCTRL + **E** = Centre textCTRL + **G** = Go To a specific page or bookmarkCTRL + **I** = Italic textCTRL + **K** = Open Insert Hyperlink windowCTRL + **M** = Indent a paragraph from the leftCTRL + **O** = Open an existing Word documentCTRL + **Q** = Remove paragraph formattingCTRL + **S** = Save Word documentCTRL + **U** = Underline textCTRL + **W** = Close Word documentCTRL + **Y** = Redo an action previously undoneCTRL + **B** = Bold textCTRL + **D** = Open font formatting windowCTRL + **F** = Find a phraseCTRL + **H** = Replace text with another textCTRL + **J** = Justify textCTRL + **L** = Left align textCTRL + **N** = Open new Word documentCTRL + **P** = Print Word documentCTRL + **R** = Right align textCTRL + **T** = Create a hanging indentCTRL + **V** = Paste textCTRL + **X** = Cut textCTRL + **Z** = Undo a previous action

M.S Excel shortcut keys:-

F2 = edit the selected cell	F5= Go to the specific cell
F7 = spell check of the selected text	F11= Create the chart
CTRL+SHIFT+ ;= enter the current time	CTRL+; = Enter the current date
ALT+SHIFT+F1= insert the new worksheet	SHIFT + F3= Open the formula window
SHIFT + F5= open the search box	CTRL+D= Fill the cell
CTRL+G= Open the go to option	CTRL+O = Open option
CTRL+P= Open the print dialogue box	CTRL+F9= Minimize the current window
CTRL+F10= Maximize the current selected window	CTRL+F6= Switch between the open worksheets
SHIFT+SPACE= Select entire row	CTRL + SPACE= Select entire column
CTRL+W= Close the window	CTRL+TAB= Move b/w two or more open excel file



Single Linear Questions

- ❖ The most common method of entering text and numerical data into a computer system is through the use of a **keyboard**.
- ❖ Unsolicited commercial email is commonly known as **Spam**.
- ❖ Which device is used for dividing a network into segments- **Switch**
- ❖ **Executing** is the process of carrying out commands.
- ❖ Editing a document consists of reading through the document you've created, then- **Correcting your errors**.
- ❖ Most mail programs automatically complete the following two parts in an e-mail- **From and To**.
- ❖ Different applications and documents of windows desktop are represented by **Icon**.
- ❖ Which area in an Excel window allows entering values and formulas- **Formula Bar?**
- ❖ Fax machines and imaging systems are examples of- **Scanning devices**.
- ❖ The particular field of a record that uniquely identifies each record is called the **key field**.
- ❖ In order to tell Excel that we are entering a formula in a cell, we must begin the entry with an operator- **=(Equal)**
- ❖ **Booting** is the process when the computer is turned on and the operating system is loading.
- ❖ Numbers in table columns are usually- **Right Alignment**.
- ❖ Character in table columns are usually- **Left Alignment**.
- ❖ To combine two or more cells into a single cell is called – **Merging**
- ❖ In a relational database, this is a data structure that organizes the information about a single topic into rows (Tuple) and columns (Attributes) - **Table**
- ❖ The first computers were programmed using- : **Machine language**.
- ❖ A series of instructions that tells a computer what to do and how to do it is called a- **Instruction**
- ❖ You can use the **Address bar** to type a URL and display a web page, or type a keyword to display a list of related web pages.
- ❖ When communication in both directions and both the devices can simultaneously transmit the data known as-: **Full duplex**
- ❖ **Collaborative software:** Groupware, such as Lotus Notes or Microsoft Exchange
- ❖ **Certification:** Skills and knowledge assessment process.

- ❖ **Computer Crime:** The act of stealing, cheating or otherwise defrauding an organization with the use of a Computer.
- ❖ **Cryptography:** Method used to protect privacy and security on the internet
- ❖ **DBMS:** An acronym for the database management system. A program that maintains and controls the access to collection of related information in electronic files.
- ❖ **Data:** Facts coded and structured for subsequent processing, generally using a computer system.
- ❖ **Digital signature:** Encrypted signature used for providing security for the messages/data transferred through the internet.
- ❖ **Digital computer:** A device that manipulates discrete data and performs arithmetic and logic operations on these data.
- ❖ **Data transmission:** The movement of data from one location of storage to another. If the locations are geographically far away, generally done via satellites.
- ❖ **Disk Mirroring:** The data is written on two or more hard disks simultaneously over the same channel
- ❖ **Disk Duple Xing:** The data is written on two or more hard disks simultaneously over the different channel
- ❖ **Dumb Terminals:** Hardware configuration consisting of a keyboard and monitor that is capable of sending and receiving information but has no memory or processing capabilities.
- ❖ **Download:** Process of transferring a file system from one system to another
- ❖ **E-commerce:** Business transactions conducted over extranets or the internet
- ❖ Enterprise, resource planning: An integrated system of operation application combining logistics, production, contract and order management, sales forecasting and financial and HR management
- ❖ **Data processing:** It is a method concerning with the systematic recording, arranging, filing, processing and dissemination of facts of business
- ❖ The **Undo button** on the quick access Toolbar allows you to cancel your recent commands or actions.
- ❖ A gigabyte represents approximately **one billion** memory locations.
- ❖ **Merging cells** involves creating a single cell by combining two or more selected cells.
- ❖ The horizontal and vertical lines on a worksheet are called— **gridlines** To delete an incorrect character in a document delete key to erase to the **right of the insertion point**.
- ❖ During the boot process, the BIOS looks for the **system files**.
- ❖ **Multitasking** is the ability of an operating system to control the activities of multiple programs at the same time.
- ❖ The unique signal, generated by a device, that tells the operating system that it is in need of immediate attention is called an- **Interrupt**.
- ❖ The blocks of code, included in the operating system, that software applications interact with are known as: **Application programming interfaces (APIs)**.

- ❖ MS-DOS is a **command-driven operating system**.
- ❖ **SRAM** retains data as long as power is provided to the memory chip and need not be refreshed periodically. SRAM stands for **Static Random Access Memory**.
- ❖ The data on **DRAM** continues to move in and out of the memory as long as power is available and must be continually refreshed to maintain the data. DRAM stands for **Dynamic Random Access Memory**.
- ❖ **Impact printers** create an image by using some mechanism to physically press an inked ribbon against the page, causing the ink to be deposited on the page in the shape desired. **Examples of Impact Printers are** Character Printers and Dot Matrix Printers.
- ❖ **Non – Impact Printers** do not touch the paper when creating an image. **Examples of Non - Impact Printers are** Inkjet printers, Laser printers, Solid ink printers, Dye- sublimation, Thermal wax printers, Thermal auto chrome printers.
- ❖ An **Integrated Software** is a single application that combines major features of several types of application.
- ❖ A **Hyperlink** is a reference to data that the reader can directly follow either by clicking or by hovering or that is followed automatically
- ❖ The **Uniform Resource Locator**, abbreviated as URL is a specific character string that constitutes a reference to a resource. In most web browsers, the URL of a web page is displayed on top inside an address bar. An example of a typical URL would be "<http://www.makemyexam.in>".
- ❖ An **interrupt handler** is a special numeric code that indicates the priority of a request.
- ❖ A **spooler** is a program that coordinates the print jobs that are waiting to print.
- ❖ **Virtual memory** is typically located on the hard drive.
- ❖ The purpose of a **swap (or page)** file is to hold a program's data or instructions in virtual memory when it can't fit in RAM.
- ❖ The definition of **thrashing** is swapping data between virtual memory and RAM too frequently.
- ❖ Verification of a login name and password is known as **authentication**.
- ❖ The correct sequence of actions that takes place during the **boot-up process**?
- ❖ **Activate BIOS -> Perform POST -> Load operating system -> Check configuration settings**
- ❖ The BIOS stored on a ROM chip, is responsible for loading the operating system from its permanent location on the hard drive into RAM.
- ❖ The memory resident portion of the operating system is called the— **kernel**.
- ❖ The **World Wide Web** (abbreviated as WWW or W3, commonly known as the Web) is a system of interlinked hypertext documents that are accessed via the Internet.
- ❖ **CC (Carbon Copy)** in e – mail indicates those who are to receive a copy of a message addressed primarily to another. The list of CC recipients is visible to all other recipients of the message.
- ❖ An additional **BCC (blind carbon copy)** field is available for hidden notification; recipients listed in the BCC field receive a copy of the message, but are not shown on any other recipient's copy (including other BCC recipients)
- ❖ **power-on self-test (POST)**
- ❖ Using Windows Explorer, a plus (+) sign in front of a folder indicates— the folder contains subfolders.
- ❖ In Windows XP, if you want to see the file size and modified dates of all files in a folder, the best viewing option is the **Details view**.
- ❖ The primary purpose of software is to turn **data** into Information.
- ❖ A directory within a directory is called-**Sub Directory**.
- ❖ A **compiler** translates a program written in a high-level language into Machine language.
- ❖ A programming language contains specific rules and words that express the **logical steps of an algorithm**.

- ❖ The simultaneous processing of two or more programs by multiple processors is **Multiprocessing**.
- ❖ The secret code that restricts entry to some programs-**Password**
- ❖ Computers use the **binary number** system to store data and perform calculations.
- ❖ **Executing** is the process of carrying out commands.
- ❖ Softcopy is the intangible output, so then what is hardcopy - **The printed output**
- ❖ An error in a computer program is called as- **Bug**
- ❖ **Backup** is - Protecting data by copying it from the original source to a different destination.
- ❖ In page preview mode-**You can see all pages of your document**
- ❖ A collection of interrelated records is called – **Database**
- ❖ To move to the beginning of a line of text, press the **Home** key.
- ❖ The term ‘**user interface**’ refers to—What the user sees on the screen and how they can interact with it.
- ❖ Reusable optical storage will typically have the acronym-**RW**
- ❖ Text in a column is generally aligned – **Left**
- ❖ In Excel, Charts are created using which option -**Chart Wizard**
- ❖ The **Mouse pointer** becomes different shapes depending on the task you are performing.
- ❖ ‘MICR’ technology used for clearance of cheques by banks refers to—**Magnetic Ink Character Recognition**
- ❖ Modern Computers represent characters and numbers internally using one of the following number systems- **Binary**
- ❖ Smallest storage unit of a computer is-**Bit**
- ❖ A MODEM is connected in between a telephone line and a—**Computer**
- ❖ **E-governance**-Delivery of public services through internet
- ❖ ‘**Buy Now–Pay Now**’ is commonly used for -**Visa Cards**
- ❖ Correcting errors in a program is referred to as- **debugging**
- ❖ An assembler is used to translate a program written in- **Assembly language**
- ❖ The capability of the operating system to enable two or more than two programs to execute simultaneously in a single computer system by using a single processor is-**Multitasking**
- ❖ Which keys can be used together with other keys for special tasks - **Ctrl, Shift**
- ❖ Which is the part of a computer that one can touch and feel-**Hardware**
- ❖ A device that reads the information contained on a disk and transfers it to the computer’s memory- **disk drive**
- ❖ The different styles of lettering in a word processing program-**font**
- ❖ Any letter, number, or symbol found on the keyboard that you can type into the computer- **character**
- ❖ A program which helps create written documents and lets you go back and make corrections as necessary- **word processor**
- ❖ A place that a user can create to store files- **folder**
- ❖ Start or restart the computer-**boot**
- ❖ A blinking indicator that shows you where your next action will happen-**cursor**
- ❖ Commands at the top of a screen such as: FILE-EDIT-FONT-TOOLS to operate and change things within programs- **menu bar**
- ❖ The command used to remove text or graphics from a document. The information is then stored on a clipboard so you can paste it- **cut**
- ❖ A removable magnetic disc that holds information-**hard drive**
- ❖ A command to get a file you worked on from the memory where it was stored-**open**
- ❖ To move down a page in a document-**scroll**
- ❖ A program that works like a calculator for keeping track of money and making budgets-**spreadsheet**

- ❖ All of the following are examples of real security and privacy risks EXCEPT- **spam**.
- ❖ A process known as **data mining** is used by large retailers to study trends.
- ❖ **Point-of-sale (POS)** terminals (formerly known as cash registers) are often connected to complex inventory and sales computer systems.
- ❖ The ability to recover and read deleted or damaged files from a criminal computer is an example of a law enforcement specialty called- **computer forensics**.
- ❖ Surgeons can perform delicate operations by manipulating devices through computers instead of manually. This technology is known as- **robotics**.
- ❖ Technology no longer protected by copyright, available to everyone, is considered to be-**proprietary**.
- ❖ **Nano science** is the study of molecules and structures whose size ranges from 1 to 100 nanometers.
- ❖ **Artificial intelligence (AI)** is the science that attempts to produce machines that display the same type of intelligence that humans do.
- ❖ The name for the way that computers manipulate data into information is called:-**processing**.
- ❖ In the binary language each letter of the alphabet, each number and each special character is made up of a unique combination of-**eight bits**.
- ❖ The term bit is short for- **binary digit**.
- ❖ The components that process data are located in the- **system unit**
- ❖ The CPU and memory are located on the- **motherboard**.
- ❖ Word processing, spreadsheet, and photo-editing are examples of-**application software**.
- ❖ Software is a set of computer programs used on a computer to help perform tasks.
- ❖ The PC (personal computer) and the Apple Macintosh are examples of two different-**platforms**.
- ❖ Servers are computers that provide resources to other computers connected to a-**network**.
- ❖ **Supercomputers** are specially designed computers that perform complex calculations extremely rapidly.
- ❖ DSL is an example of a broadband connection.
- ❖ The difference between people with access to computers and the Internet and those without this access is known as the-digital **divide**.
- ❖ Nanotechnology is the science revolving around the use of nanostructures to build devices on an extremely small scale.
- ❖ A byte can hold one **character** of data.
- ❖ The operating system controls the way in which the computer system functions and provides a means by which users can interact with the computer.
- ❖ **Embedded computers** are specially designed computer chips that reside inside other devices, such as your car or your electronic thermostat.
- ❖ The steps and tasks needed to process data, such as responses to questions or clicking an icon, are called: A. instructions-**the operating system**.
- ❖ The metal or plastic case that holds all the physical parts of the computer is the-**system unit**. Input devices are used to provide the steps and tasks the computer needs to process data, and these steps and tasks are called **instructions**.
- ❖ When you connect to the Internet your computer is communicating with a server at your **Internet service provider (ISP)**
- ❖ The earlier computers, which were massive in size, were based on **vacuum tubes**.
- ❖ Early computing machines, like the **ENIAC**, were actually meant to assist the armed forces.
- ❖ An improvement on the ENIAC, which pioneered 'stored program', was made possible with the help of the mathematician **John von Neumann**.

- ❖ The B-programming language was developed by **Ken Thompson**.
- ❖ Famous people, associated with the ENIAC, EDVAC, UNIVAC computers are **Eckert & Mauchly**.
- ❖ The 1st commercially produced and sold computer (1951) was **UNIVAC**.
- ❖ IBM was provided software for PCs by **Microsoft**.
- ❖ The transformation from heavy computers to PCs was made possible using **microprocessors**.
- ❖ The first microprocessor was developed in **1971 by Intel**.
- ❖ The term 'micro' (extremely small) denotes **10-6m**.
- ❖ The Harvard student, who chose to write computer programs and dropped studies was **Bill Gates**.
- ❖ A Pentium 4 (P-4) employs roughly **40 million transistors**.
- ❖ A program used to browse the web is called **Web browser**.
- ❖ An error in software designing which can even cause a computer to crash is called bug.
- ❖ The device which sends computer data using a phone line is called **MODEM**.
- ❖ The first home computer (1977), which was sold in millions of units was **Apple II**.
- ❖ '**PARAM-8000**' is a First supercomputer in India.
- ❖ A website containing periodic posts is called **blog**.
- ❖ The unwanted or non-requested emails are called "spam".
- ❖ A computer framed to give various network services is called **server**.
- ❖ The first computers were programmed using **Machine language**.
- ❖ A filename is a **unique name** that you give to a file of information.
- ❖ A series of instructions that tells a computer what to do and how to do it is called a **program**.
- ❖ **Super computers** refers to the fastest, biggest and most expensive computers
- ❖ The rectangular area of the screen that displays a program, data, and or information is a **window**
- ❖ The process of a computer receiving information from a server on the internet is known as **downloading**
- ❖ You can use the tab key to move a cursor **across the screen, indent a paragraph**.
- ❖ A collection of related files is called **record**.
- ❖ Storage that retains its data after the power is turned off is referred to as **non-volatile storage**.
- ❖ **Testing** is the process of finding errors in software code.
- ❖ Syntax contains specific rules and words that express the logical steps of an algorithm.
- ❖ Changing an existing document is called the **editing documentation**
- ❖ The windows key will launch the **start buttons**.
- ❖ To move to the beginning of a line of text, press the **home key**.
- ❖ Information travels between components on the motherboard through **buses**.
- ❖ A tool bar contains **buttons and menus** that provide quick access to commonly used commands
- ❖ One advantage of **dial-up internet** access is it utilizes existing telephone security
- ❖ Protecting data by copying it from the original source is **backup**

- ❖ In a **relational database**, table is a data structure that organizes the information about a single topic into rows and columns.
- ❖ When the pointer is positioned on a **hyperlink** it is shaped like a hand .
- ❖ A **compiler** translates higher level programs into a machine language program, which is called object code
- ❖ The ability to find an individual item in a file immediately **Direct access** .
- ❖ Each box in a spread sheet is called a **cell**.
- ❖ Network components are connected to the same cable in the **bus topology**.
- ❖ **Scanner** will translate images of text, drawings and photos into digital form.
- ❖ **MS-DOS** is a single user operating system
- ❖ **Ethernet** is used for high speed telecommunications
- ❖ **FORTRAN** is a scientific computer language
- ❖ Connections to the internet using a phone line and a modem are called **dial-up connections**
- ❖ Restarting a computer that is already on is referred to as **warm booting**
- ❖ A cluster represents a group of **sectors**
- ❖ **Boot sector viruses** are often transmitted by a floppy disk left in the floppy drive
- ❖ A goal of normalization is to minimize the number of **redundancy**
- ❖ A **proxy server** is used to process client request for web pages
- ❖ When data changes in multiple list and list are not updated, this causes **data inconsistency**
- ❖ Granting an outside organization access to internet web pages is often implemented using a extranet
- ❖ The code that relational database management systems use to perform their database task is refer to as **SQL**
- ❖ **Data integrity** means that the data contained in the database is accurate and reliable
- ❖ The IBM made the first electronic computer in **1953**
- ❖ **Control panel** is used for increasing and decreasing the speed of the cursor of mouse
- ❖ The **.mpeg** is the format of a movie file
- ❖ The memory address sent from the CPU to the main memory over a set of wires is called **address bus**
- ❖ The enhanced keyboard contains 101 keys
- ❖ **Cache memory** is a part of main memory
- ❖ The central host computer or file server in a star network maintains control with its connecting devices through **polling**
- ❖ The integration of all kinds of media such as audio, video, voice, graphics and text into one coherent presentation combined is called **multimedia**
- ❖ A technique for searching special databases, called data warehouses, looking for related information and patterns is called **data mining**
- ❖ **Batch processing** is a technique in which a number of similar items or transactions are processed in groups or batches during a machine run
- ❖ **Browser** is a link between the computer and the internet. It's actually a program that provides a way to look in the hand interact with all information on the internet. A browser is a client program that uses the Hypertext Transfer Protocol (http)
- ❖ **Computer Crime:** The act of stealing, cheating or otherwise defrauding an organization with the use of a computer
- ❖ **Cryptography:** Method used to protect privacy and security on the internet
- ❖ **Digital signature:** Encrypted signature used for providing security for the messages/data transferred through the internet
- ❖ **E-commerce:** Business transactions conducted over extranets or the internet
- ❖ **Electronic data interchange (EDI)** : Electronic transmission or documents through point to point connections using a set of standard forms, message and data elements, this can be via leased lines private networks or the internet



Important Abbreviations

ANSI —American National Standards Institute	EEPROM —Electrically Erasable Programmable Read-Only Memory
ARPANET —Advanced Research Projects Agency Network	EPROM —Erasable Programmable Read-Only Memory
ASCII —American Standard Code for Information Interchange	FDD —Floppy Disk Drive
ISCII — Indian Standard Code for Information Interchange	GUI —Graphical User Interface
ASP —Active Server Pages	HDD —Hard Disk Drive
BASIC —Beginner's All-Purpose Symbolic Instruction Code	HTML —Hypertext Markup Language
CDMA —Code Division Multiple Access	HTTP —Hypertext Transfer Protocol
CD-R —CD-Recordable	HTTPS —Secure Hypertext Transport Protocol
CD-RW —CD-Rewritable	ISO —International Organization for Standardization
COBOL —Common Business-Oriented Language	ISP —Internet Service Provider
DBMS —Database Management System	Kb —Kilobit
DVD —Digital Versatile Disc or Digital Video Disc	KB —Kilobyte
ENIAC —Electronic Numerical Integrator and Computer	LCD —Liquid Crystal Display
EDSAC —Electronic Delay Storage Automatic Calculator	LIFO —Last In First Out
EDVAC —Electronic Discrete Variable Automatic Computer	MAC —Media Access Control
	MAPI —Messaging Application Programming Interface
	MTA —Mail Transfer Agent
	OSS —Open-Source Software
	PAN —Personal Area Network
	PERL —Practical Extraction and Reporting Language
USB —Universal Serial Bus	AMD – Advance Micro Device
VLAN —Virtual Local Area	ASPI – Advacne Scsi Programming Interface
RDBMS —Relational Database Management System	ASIC – Application Specific Integrated Circuit
XML —Extensible Markup Language	USB – Universal Serial Bus.
ASP —Active Server Pages	VIRUS – Vital Information Resource Under Seized.
API —Application Programming Interfaces	MIME —Multipurpose Internet Mail Extensions
CSS —Cascading Style Sheets	JAD – Java Application Development
ASCII —American Standard Code For Information Interchange	MIDI – Musical Instrument Digital Interface
XSL —Extensible Style Sheet Language	MPEG – Motion Picture Experts Group
AVI – Audio Video Interleaved	PDF – Portable Document Format
CDA – Compact Disk Audio	SQL —Structured Query Language
DLL – Dynamik Link Library	SRAM —Static Random Access Memory
JPEG – Joint Photographic Expert Group	TTL —Transistor-Transistor Logic
VHF – Very High Frequency.	UML —Unified Modeling Language
UHF – Ultra High Frequency.	RAID —Redundant Array of Independent Disks
ALU —Arithmetic Logic Unit	RDBMS —Relational Database Management System
URL – Uniform Resource Locator.	RISC —Reduced Instruction Set Computer
	GIF – Graphics Interchange Format

C. 128bits
E. 32bits.

D. 16bits

14. Which one is called as modifier key?

- A. Caps Lock key B. Num Lock key
C. CTRL key D. Esc key

15. In OSI Model Router used in which layer?

- A. Application Layer B. Session layer
C. Network layer D. Data link layer
E. Physical layer

16. Magnetic disk is coated by?

- A. Silicon B. Iron oxide
C. Aluminum D. Glass
E. None of the above

17. In HTTPs protocol S stands for

- A. Source B. Secure
C. Set D. Simple
E. None of these

18. If you see #### in a cell the meaning is that –

- A. Row width is low
B. Column width is low
C. Both row and column width is low
D. Column and row width is high
E. None of these

19. A computer provides database services to other computers, then it will be called as ?

- A. Application server B. Database server
C. File server D. Web server
E. Proxy server

20. GUI stands for -

- A. Graphical user Instrument
B. Graphical unified Interface
C. Graphical unified Instrument
D. Graphical user Interface
E. Graphically user Instrument

21. 1 KB=? Bits-

- A. 8193 B. 8916
C. 8192 D. 1024
E. 4024

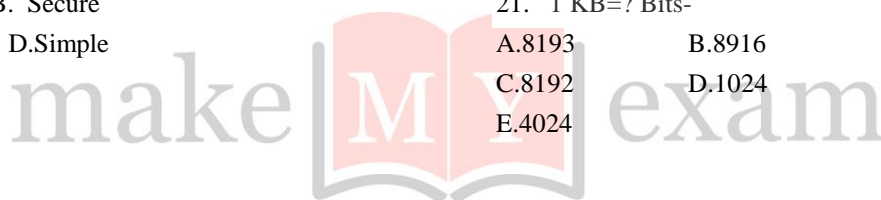

22. The copy command saves to:
 A. the desktop B. the clipboard
 C. Microsoft Word D. Paste
 E. None of these
23. Vacuum Tube is the inventiongeneration.
 A. 1st generation B. 2nd gen
 C. 4th gen D. 5th gen
 E. None of these
24. The computer size was very large in ____
 A. First Generation B. Second Generation
 C. Third Generation D. Fourth Generation
 E. None of these
25. ____ is responsible for overall control and co-ordination of instruction execution.
 A. CPU B. ALU
 C. RAM D. Control Unit
 E. None of these
26. Which of the following is the fastest type of computer?
 A. Minicomputer B. Mainframe computer
 C. Supercomputer D. Digital computer
 E. None of these
27. Find out the technology of third generation?
 A. Vacuum tube B. transistor
 C. I.C's D. Microprocessor
 E. None of the above
- (28-32). In a code language, the symbol for '0' is '#' and for '1' is '\$'. Numbers greater than one is to be written only by using the two symbols that given above. Follow some instruction that are given below -
 A. 0 is written as #, B. 1 is written as \$,
 C. 2 is written as ##, D. 3 is written as \$\$, so on
28. Which of the following will represent 22?
 A. ##\$\$# B. \$#\$\$\$
 C. \$#\$\$\$ D. \$##\$#
- E. None of the above
29. Which of the following will represent 53?
 A. ##### B. \$#\$##
 C. \$\$\$#\$ D. \$#\$\$\$#
 E. None of the above
30. Which of the following will represent the value of - (### + \$\$ \$ * # \$ \$) = ?
 A. 35 B. 36
 C. 37 D. 38
 E. 39
31. Which of the following will represent the value of - (#### + ##### ÷ ###) = ?
 A. 28 B. 57
 C. 26 D. 55
 E. None of the above?
32. $(3457)_8 = (?)_{16}$
 A. 725 B. 7215
 C. 72F D. 72E
 E. None of the above.
33. In Normalization BCNF is needed because:
 A. BCNF is need when the Data is deleted tuples may be lost
 B. Otherwise tuples may be duplicated
 C. Updating is otherwise is difficult
 D. When there is dependent attributes in two possible composite keys one of the attribute is unnecessarily duplicated in the tuples.
 E. None of these
34. In OSI model Data link layer is divided into -
 A. MAC and Session layer
 B. MAC and LLC layer
 C. MAC and Physical layer
 D. LLC and Transport layer
 E. None of the these

35. 255.255.255.0 subnet mask of which class?
A. Class A B. Class B
C. Class C D. Class D
E. Class E
36. _____ is a set of programs, located at a network gateway server that protects the resources of a private network from other networks:
A. Root kit B. Firewall
C. Sandbox D. Password Cracker
E. None of these
37. Which of the following is not an input device?
A. OCR B. Optical scanners
C. Voice recognition device
D. COM (Computer Output to Microfilm)
E. None of these
38. Who among the following is the odd one _____?
A. Mouse B. Scanner
C. Printer D. Keyboard
E. None of these
39. Which is not a storage device?
A. Printer B. CD
C. Hard disk D. Floppy Disk
E. DVD
40. _____ technologies is used by banks for faster processing of large volumes of cheques.
A. OCR B. OMR
C. MICR D. Bar code
E. None of these
41. Who invented Analytical engine?
A. Blaise Pascal B. George Bool
- C. Charles Babbage D. Dr. Herman Hollerith
E. None of these
42. Memory which forgets everything when you switch off the power is known as _____.
A. Corrupted B. Volatile
C. Non-Volatile D. Non-Corrupted
E. NonE.
43. Which of the following code used in present day computing was developed by IBM Corporation?
A. ASCII B. Hollerith Code C.EBCDIC Code
D. Baudot Code
E. None of these
44. An image editing software in which we can draw and edit images is?
A. PageMaker B. MS-Paint
C. Coral Draw D. Photo Image E. Front
45. Physical components that make up your computer are known as _____.
A. Software B. Operating Systems
C. Hardware D. Web Browsers
E. None of these
46. What is warm booting?
A. When a computer is turned on after it has been completely shut down.
B. When a computer is restarted by pressing the restart button or pressing (ctrl + Alt + Del) key.
C. A. or B.
D. NonE.
47. Which of the following is a function of Operating

System (OS)?

- A. Process & Memory Management
- B. File Management
- C. Input/Output Management
- D. All of the above

48. Which of the following is an example of Single User Operating System?

- A. MS-DOS
- B. Windows 9X
- C. A. & B.
- D. None

49. Which of the following is an example of Multi User Operating System?

- A. UNIX
- B. LINUX
- C. Windows 2000/2007
- D. A. & B. & C.

50. MICR stand for?

- A. Magnetic Ink character Register
- B. Magnetic Ink Code Reader
- C. Magnetic Ink Code Register
- D. Magnetic Ink character Recognition
- E. Magnetic Ink cases Reader

51. Virtual memory is _____?

- A. Memory on the hard disk that the CPU uses an extended RAM.
- B. Access the page table
- C. CPU generates a physical address
- D. Automatic storage allocation
- E. None of these

52. What is the full form of SIM?

- A. Station Identity Module
- B. System Identity Module
- C. Subscriber Identity Module
- D. Subscriber Trunk Dialing
- E. None of these

53. A _____ is a software program used to view Web pages.

- A. Site
- B. Host
- C. Link
- D. Browser
- E. None of these

54. Micro-programming introduced by _____?

- A. John Mauchley
- B. Maurice Wilkies
- C. William Shockley
- D. Blaise pascal
- E. None of these

55. Numbers and formulae entered in a cell are called _____.

- A. Labels
- B. Numeric entries
- C. Intersection
- D. Text
- E. Fellers

56. TCP /IP protocol stack is –

- A. Combination of TCP and IP Protocol
- B. A Family of protocol that connect to PCs
- C. Part of internet
- D. Both b and c
- E. None of these

57. When talking of software budget –

- A. It includes only direct development cost
- B. Productivity loss that occurs during IT Training
- C. Indirect cost of budget include training cost
- D. both a and c
- E. None

58. Which of the following makes a network insecure?

- A. Encryption
- B. NIC (Network interface card)
- C. Static keys
- D. Either B or C
- E. None of these

59. Artificial Intelligence can be used in every sphere of life because of its

- A. Ability to work in hazardous places
- B. Ability to think like human beings
- C. Ability to work in artificial environments
- D. All of the above
- E. None

60. Software Quality assurance is for

- A. Error prevention
- B. Error detection
- C. Error correction
- D. Either a or C.
- E. None of these.

61. IN OOPS technology hiding the complexity of characteristics is called as –
- A. Abstraction B. Inheritance
C. Object D. Polymorphism
E. Encapsulation
62. The IP Address 135.0.10.27 belong to the address class_____?
- A. Class A B. Class B
C. Class C D. Class D
E. Class E
63. Which of the following is not a binary system?
- A. EBCDIC B. ASCII
C. HEX D. Both a and b
E. None
64. 1 AND 1 will give
- A. 1 B. 0
C. Both A and B D. 10
E. None
65. Computer to Computer communication for business transaction is called as-
- A. PIN B. EDI.
C. AIM D. Both a and c
E. None
66. Fax machines are used to send documents through a?
- A. Telephone line B. Modems
C. Co-axial wire D. All of these
E. None of these
67. Date and time are available on the desktop at_____.
- A. Keyboard B. Recycle bin
C. My computer D. Task bar
E. None of these
68. To save an existing file with new name at a new location we should use_____command.
- A. Save B. Save and replace
C. Save as D. New file
E. None of these
69. A red wavy line under a word indicates that the word_____.
- A. Is too long for the line of text
B. Is not in the dictionary file and therefore might be spelt incorrectly
C. Is not appropriate for that particular sentence
D. Is a verb
E. None of these.
70. Windows xp, windows 7, windows 10 are known as.....?
- A. Processors B. Domain names
C. Modems D. Operating system
E. None of these.
71. _____ is when the more power-hungry components, such as the monitor and the hard drive are put in idle.
- A. Hibernation B. Power down
C. Standby mode D. shutdown procedure
E. None of these.

72. Which of the following is an operating system?
A. Linux
B. Debugger
C. Mozilla
D. Google chrome
E. Intel 8085
73. Which of the following cables can transmit data at high speeds?
A. Flat cables
B. Coaxial cable
C. Optic fiber cable
D. Twisted pair cable
E. UTP cable
74. What is the base of hexadecimal number system?
A. 2
B. 8
C. 16
D. 10
E. None of these..
75. RTGS stand for _____.
A. Real Time Gross Settlement
B. Real Time General Settlement
C. Run Time Gross Settlement
D. Regular Time General Settlement
E. None of these
76. What is the name given to the temporary storage area that a web browser uses to store pages and graphics that it has recently opened?
A. Niche
B. Cookies
C. Cache
D. Cellar
E. None of these
77. Oracle is an example of _____ application software.
A. Database
B. Word processing
C. Project management
D. Presentation graphics
E. Desktop
78. MySQL is _____?
A. A hierarchical model
B. A RDBMS
C. A relational model
D. A Database
E. None of these
79. Primary key is a _____?
A. Common key
B. Unique key
C. Input key
D. Output key
E. None of these
80. Which of the following computer language is a mathematically oriented languages used for scientific problems?
A. FORTRAN
B. COBOL
C. LISP
D. PROLOG
E. APPLE
81. Which of the following is NOT a computer programming language?
A. C
B. C++
C. Java
D. COBOL
E. Microsoft
82. Which of the following is not an operating system?
A. DOS
B. UNIX
C. MAC (OS)
D. DBMS
E. Windows XP
83. One nibble is equal to how many bits?
A. 4 bits
B. 8 bits
C. 12 bits
D. 16 bits
E. None of these
84. Verification of a Login name and password is known as _____.
A. Configuration
B. Accessibility
C. Authentication
D. Logging in
E. None of these
85. Which of the following can be used to select the entire document?
A. Ctrl+A
B. Alt+F5
C. Shift+A
D. Ctrl+K
E. Ctrl+H
86. Which of the following will you require to hear music on your computer?
A. Video Card
B. Sound Card
C. Mouse
D. Joy Stick
E. None of these

87. Layer which converts data frames into bits and also convert bits into frames is known as.....
- A. Data Link Layer B. Transport Layer
C. Session Layer D. None
88. Layer which deals with router.....
- A. Network Layer B. Transport Layer
C. Session Layer D. None
89. Layer which manages MAC address
- A. Presentation Layer B. Transport Layer
C. Session Layer D. Data Link Layer
90. Layer which establishes, maintains & terminates a connection while communicating with other client is known as.....
- A. Presentation Layer B. Transport Layer
C. Session Layer D. None
91. Layer which translates data format & deals with compression of data and network security is known as.....
- A. Presentation Layer
B. Application Layer
C. Session Layer
D. None
92. Layer which is the user interface to access the network services such as file transfer/ database access is known as.....
- A. Presentation Layer
B. Application Layer
C. Session Layer
D. None
93. A long message that needs to be transmitted is broken into smaller packets of fixed size for error free transmission is termed as.....
- A. Data Sequencing
B. Flow Control
C. Error control
D. None
94. ICMP stands for_____?
- A. Internet Control Message Protocol
B. Internet Connection Management Protocol
C. Internet Control Management Protocol
D. None
95. What is the meaning of OSI, in terms of computers?
- A. Open Software Interrelation
B. Open System Interrelation
C. Open System Interconnection
D. Open Software Interconnection
E. None of these
96. USB in data cables stands for?
- A. Unicode smart Bus B. Universal structural Bus
C. Unicode Serial Bus D. Universal serial Bus
E. None of these
97. You must install a (n) _____ on a network if you want to share a broadband Internet connection.
- A. router B. modem
C. node D. cable
E. None of these
98. To reload a web page, press the ____ button.
- A. Redo B. Reload
C. Restore D. Ctrl
E. Refresh
99. _____ mouse uses laser rays for the movement of cursor.
- A. Mechanical mouse B. Optical mouse
C. Magnetic mouse D. Normal mouse
E. None of these
100. Disk access times are measured in _____?
- A. minute B. Milliseconds
C. Hours D. seconds
E. None of these
101. Blaise Pascal has introduced_____?
- A. Adding machine B. Abacus
C. Calculator D. difference engine

- E. None of these
102. Sending an e-mail is similar to _____.
A. Petering an event B. Narrating a store
C. Writing a letter D. Creating a drawing]
E. None of these
103. You can use the _____ bar to type a URL and display a webpage or type a keyword to display a list of related webpages.
A. Menu B. Title
C. Search D. Web
E. Address
104. A web _____ consists of one or more Web pages located on a Web server.
A. Hub B. Site
C. Story D. Template
E. None of these
105. _____ are used to identify a user who returns to a Website.
A. Cookies B. Plug-ins
C. Scripts D. ASPs
E. None of these
106. The _____ specifies the operation to be performed and the operands provide the data on which the operation is to be performed:
A. source code B. opcode
C. object code D. program code
E. None of these
107. Which of the following is Open Source Software?
A. Windows B. Linux
C. IOS D. Adobe Photoshop
- E. None of these.
108. What is the name of the software that allows us to browse through web pages called?
A. Browser B. Mail client
C. FTP client D. Messenger
E. None of these
109. When you purchase a product over a Mobile Phone, the transaction is called _____.
A. Web commerce B. e- commerce
C. m-commerce D. Mobile Purchase
E. None of these.
110. Named collection of fields which represent a complete unit of information is called _____.
A. Field B. Record
C. Table D. File
E. None of these
111. A _____ is a grid with labeled columns and rows.
A. Dialog box B. Worksheet
C. Clipboard D. Toolbar
E. None of these.
112. An example of a telecommunication device is a _____.
A. Keyboard B. Mouse
C. Modem D. Printer
E. Scanner
113. Programs that automatically submit your search request to several search engines simultaneously are called _____.
A. Metasearch engines B. Webcrawlers

C. Spiders
E. None of these

D. Hits

A. DNS

C. UTP

E. None of these

B. MNS

D. RTP

114. What kind of Protocol is used to provide Internet access from mobile?

A. TCP/IP

B. ISD

C. WAP

D. HTTP

E. None of these

115. What is the slowest transmission medium?

A. Twisted pair wire

B. Coaxial cable

C. Fiber optic cable

D. All of above

E. None of these

116. What is an e-mail attachment?

A. A receipt sent by the recipient

B. A separate document from another program sent along with an e-mail message

C. A malicious parasite that feeds off of you messages and destroys the contents

D. A list of CC and BCC recipients

E. None of these

117. The _____ program compresses large files into a smaller file.

A. WinZip

B. WinShrink

C. WinStyle

D. Microsoft

E. None of above

118. The _____ folder retains copies of message that you have started but are not yet ready to send.

A. Inbox

B. Outbox

C. Drafts

D. Sent Items

E. Address Book

119. Which is not an internet protocol?

A. HTTP

B. FTP

C. STP

D. UDP

E. None of these

120. What kind of server converts IP addresses to domain names?

121. POST stands for _____.

A. Power On Selfie Test

B. Power One Self-Test

C. Power On Self-Test

D. Power On Self-Testing

E. None of these

122. Which of the following is a network in which computers are located physically close together, often in the same building?

A. LAN

B. WAN

C. RAM

D. ROM

E. None of these

123. Programs such as Mozilla Firefox that serve as navigable windows into the Web are called _____.

A. Internet

B. Data card

C. Web browsers

D. RAM

E. None of these

124. Start or restart the computer means ____.

A. exit

B. kick

C. boot

D. kick-start

E. None of these

125. You click at B to make the text _____.

A. Italics

B. Underlined

C. Italics and under lined

D. Bold

E. None of these

126. Each _____ on a menu performs a specific action.

A. Client

B. Server

C. Node

D. Command

E. None of these

127. An e-mail address typically consists of a user ID followed by the ____ sign and the name of the e-mail server that manages the user's electronic post office box.

- A. data traffic pattern
C. infinite loop

- B. data highway
D. feedback loop

142. A language reflects the way people think mathematically is.....

- A. cross platform programming
B. functional
C. event driven programming
D. 3GL business programming

143. A mistake in an algorithm that causes incorrect results is called A....

- A. logical error B. syntax error
C. procedural error D. compiler error

144. A device for changing the connection on a connector to a different configuration is....

- A. a converter B. a component
C. an attachment D. an adapter

145. Technique that is used to send more than one call over a single line is

- A. Digital transmission B. Infrared transmission
C. Streaming D. Multiplexing

146. Which of the following would you find on LinkedIn?

- A. Games B. Connections
C. Chat D. Applications

147. The method of Internet access that requires a phone line, but offers faster access speeds than dial-up is the.....Connection

- A. Cable access
B. Satellite access
C. Fiber optic service
D. Digital Subscriber Line (DSL)

148.is a form of denial of service attack in which a hostile client repeatedly sends SYN packets to every port on the server using fake IP addresses.

- A. Cyber crime B. Memory shaving
C. Synflooding D. Software Piracy

149. A program either talk or music that is made available in digital format for automatic download over the internet is called A.....

- A. wiki B. broadcast
C. vodcast D. podcast

150. A USB communication device that supports data encryption for secure wireless communication for notebook users is called A...

- A. USB Wireless Network adapter
B. wireless switch
C. wireless hub
D. router

151. The connection between your computer at home and your local ISP is called.....

- A. the last mile B. the home stretch
C. the home page D. the vital mile

152are attempts by individuals to obtain confidential information from you by falsifying their identity through e-mails.

- A. Phishing trips B. Viruses
C. Phishing scams D. Spyware scams

153. ERP is an acronym for....

- A. Enterprise Relationship planning
B. Enterprise Resource planning
C. Enterprise Reorder planning
D. None.

154. Collecting personal information and effectively posing as another individual is known as the crime of ..

- A. spooling B. spoofing
C. hacking D. identity theft

155. Which ports connect special types of music instruments to sound cards?

- A. BUS B. CPU
C. USB D. Musical Instrument
D. Digital Interface (MIDI)

- 156.** Where you are likely to find an embedded operating system?
A. On a desktop operating system
B. On a networked PC
C. On a PDA
D. On a Mainframe.
- 156.** Name of the first computer in India-
A. Sidharth B. Param 10,000
C. CDC-6600 D. C-DAC
- 158.** Which of the following places the common data elements in order from smallest to largest?
A. Bit, byte, character, record, field, file, database
B. Database, file, record, field, character
C. Character, file, record, field, database
D. Character, field, record, file, database
- 159.** Which protocol provides e-mail facility among different hosts?
A. File Transfer Protocol (FTP)
B. TELNET
C. Simple Mail Transfer Protocol (SMTP)
D. Simple Network Management Protocol (SNMP)
- 160.** Which of the following memory is non-volatile?
A. DRAM B. SRAM
C. ROM D. None of the above
- 161.** What is embedded system?
A. The programme which arrives by being wrapped in box.
B. The programme which is the permanent part of the computer
C. The computer which is the part of a big computer.
D. Some combination of computer hardware and software.
- 162.** Which device connects a LAN to the Internet?
A. Adapter B. Repeater
C. Router D. None of the above
- 163.** Signals can be analog or digital and a computer that processes the both type of signals is known as?
A. Analog computer B. Digital Computer
C. Hybrid Computer D. Mainframe Computer
- 164.** Human beings are referred to as Homo sapiens, which device is called Silico Sapiens?
A. Monitor B. Hardware
C. Robot D. Computer
- 165.** EBCDIC can code up to how many different characters?
A. 256 B. 16
C. 32 D. 64
- 166.** Different components of the motherboard of a PC unit are linked together by sets of parallel electrical conducting lines. What are these lines called?
A. Conductors B. Buses
C. Connectors D. Consecutive
- 167.** Which is the first automatic electronic digital computer?
A. ENIAC B. MARK I
C. Z3
D. ABC (Atanasoff –Berry Computer)

- 168.** India's first supercomputer is
A. Cyber 205 B. Aaditya
C. Anupam D. PARAM 8000
- 169.** The metal disks, which are permanently housed in, sealed and contamination free containers are called?
A. Hard disks B. Floppy disk
C. Winchester disk D. Flexible disk
- 170.** What was the name of the first commercially available microprocessor chip?
A. Intel 308 B. Intel 33
C. Intel 4004 D. Motorola 639
- 171.** The first digital computer built with IC chips was known as
A. IBM 7090 B. Apple - 1
C. IBM System / 360 D. VAX - 10
- 172.** RATS stands for
A. Regression Analysis Time Series
B. Regression Analysis Time Sharing
C. Real Analysis Series
D. All of above
- 173.** The magnetic storage chip used to provide non-volatile direct access storage of data and that have no moving parts are known as
A. Magnetic core memory
B. Magnetic tape memory
C. Magnetic disk memory
D. Magnetic bubble memory
- 174.** A computer program that converts an entire program into machine language is called a/an
A. Interpreter B. Simulator
C. Compiler D. Commander
- 175.** A language translator that analyses and executes the source code in-line-by-line manner without looking at the entire program is called a/an
A. Interpreter B. Simulator
C. Compiler D. Commander
- 176.** Who designed the first electronics computer (ENIAC)?
A. Von Neumann
B. John Eckert & John Mauchly
C. Joseph M Jacquard
D. None of the above
- 177.** A device driver acts like a..... between the device & OS
A. inverter B. converter
C. translator D. None
- 178.** Computers can be divided into.....major categories.
A. Four (Micro, Mini, Mainframe, Super)
B. Three C. One
D. None
- 179.** SAN stands for
A. Storage Area Network
B. Super Array Network
C. Shared Area Network
D. None
- 180.** NAS stands for
A. Network Area Service
B. Network Attached Storage
C. Network Attached Service
D. None
- 181.** To produce high quality graphics (hardcopy) in color, is used
A. RGB monitor B. Plotter
C. Ink-jet printer D. Laser printer
- 182.** The scrambling of code is known as
A. Encryption B. a firewall
C. Scrambling D. None
- 183.** A type of message that web servers pass to your web browser when you visit the website

A. Cache
C. None

B. Spam
D. Cookie

184. Software that you can use free of charge for a set period. After that you have to buy it to keep working is known as

A. Freeware
C. Software

B. Shareware
D. None

185. A type of virus (malicious code) that looks for security loopholes in a system and uses that to replicate itself is known as

A. Worm
C. Trojan Horse

B. Threat
D. None

186. RAID stands for _____

A. Reproduce Array of Intelligent Disks
B. Reproduce Array of Inexpensive Disks
C. Redundant Array of Inexpensive Drives
D. Redundant Array of Inexpensive Disks

187. Software that monitors your online computer activities is known as

A. Malware
C. Freeware

B. Spyware
D. None

188. Software that is made available at no cost and is sometimes used to entice a user to purchase the unbranded version with no advertising.

A. Malware
C. Freeware

B. Spyware
D. None

189. Which is used to display one or more web pages within another normal web page?

A. IFRAME
C. Home page

B. Hyperlink
D. None

190. storage area used to store data to a compensate for the difference in speed at which the different units can handle data is

A. Memory
B. Buffer

C. Accumulator
D. None

191. Computer is free from tiresome and boardroom. We call it

A. Accuracy
C. Versatility

B. Diligence
D. None

192. Integrated Circuits (ICs) are related to which generation of computers?

A. First generation
C. Third generation

B. Second generation
D. None

193. Which type of computers uses the 8-bit code called EBCDIC?

A. Minicomputers
C. Mainframe computers

B. Microcomputers
D. None

194. The ALU of a computer responds to the commands coming from

A. Primary memory
C. External memory

B. Control section
D. Cache memory

195. A physical connection between the microprocessor memory and other parts of the microcomputer is known as

A. Path
C. Route

B. Address bus
D. All of the above

196. A technique used by codes to convert an analog signal into a digital bit stream is known as

A. Pulse code modulation
C. Query processing

B. Pulse stretcher
D. Queue management

197. The terminal device that functions as a cash register, computer terminal, and OCR reader is the?

A. Data collection terminal
B. OCR register terminal
C. Video Display terminal
D. POS terminal

198. A set of flip flops integrated together is called _____

A. Counter
C. Register

B. Adder
D. None of the above

199. A register organized to allow moving left or right operations is called a ____

- A. Counter B. Loader
C. Adder D. Shift register

200. How many address lines are needed to address each machine location in a 2048 x 4 memory chip?

- A. 10 B. 11
C. 8 D. 12

201. Multi user systems provided cost savings for small business because they use a single processing unit to link several

- A. Personal computers B. Workstations
C. Dumb terminals D. Mainframes

202. The difference between memory and storage is that memory is ____ and storage is ____

- A. Temporary, permanent
B. Permanent, temporary
C. Slow, fast
D. All of the above

203. Which of the following is the first computer to use Stored Program Concept?

- A. UNIVAC B. ENIAC
C. EDSAC D. None of above

204. 1 nibble equals to

- A. 1 bits B. 2 bits
C. 4 bits D. 8 bits

205. The most commonly used standard data code to represent alphabetical, numerical and punctuation characters used in electronic data processing system is called

- A. ASCII B. EBCDIC
C. BCD D. All of the above

206. Hard disk is coated on both sides with

- A. Magnetic metallic oxide
B. Optical metallic oxide
C. Carbon layer
D. All of the above

207. The contents of information are stored in

- A. Memory data register
B. Memory address register
C. Memory arithmetic registers
D. Memory access register

208. The programs which are as permanent as hardware and stored in ROM is known as

- A. Hardware B. Software
C. Firmware D. ROM ware

209. Which of the following memories must be refreshed many times per second?

- A. Static RAM B. Dynamic RAM
C. EPROM D. ROM

210. In which mode, the communication channel is used in both directions at the same time?

- A. Full-duplex B. Simplex
C. Half-duplex D. None of the above

- 211.** Which of the printers used in conjunction with computers uses dry ink powder?
A. Daisy wheel printer B. Line printer
C. Laser printer D. Thermal printer
- 212.** Daisy wheel printer is a type of
A. Matrix printer B. Impact printer
C. Laser printer D. Manual printer
- 213.** Which of these is considered intelligent CASE tool?
A. Workbench B. Toolkit
C. Upper CASE D. Lower CASE
- 214.** Origin of internet can be tracked from
A. Satellite networks B. Radio networks
C. ARPANET (Advanced Research Projects Agency Network)
D. None
- 215.** System proposal is prepared inphase of SDLC.
A. Conception B. Initiation
C. Analysis D. Design
- 216.** A data warehouse
A. Contains numerous naming conventions and formats
B. Is organized around important subject areas
C. Contains only current data
D. None
- 217.** To connect networks of similar protocols,are used
A. Routers B. Gateways
C. Bridges D. None
- 218.**..... is one reason for problems of data integrity
A. Data availability constraints
B. Data inconsistency
C. Data redundancy
D. None
- 219.** Which of the following is an advantage of mounting an application on the web?
A. the possibility of 24-hour access for users
B. creating a system that can extend globally
C. standardizing the design of the interface
D. All of these
- 220.** Which of the following domains is used for profit businesses?
A. .com B. .edu
C. .net D. None
- 221.** Which of the following domains is used for non-profit organizations?
A. .org B. .edu
C. .net D. None
- 222.** Browsers can be classified into two types. They are
A. Graphical & Text B. Graphical & Navigational
C. Text & Pictorial D. None
- 223.** The displayed data over internet can be classified into two types. They are
A. Static & Dynamic B. Graphical & Text
C. Data & Voice D. None
- 224.** Which is an open source development environment to develop dynamic web pages?
A. PHP (Hypertext Preprocessor) B. XML
C. VB Script D. None
- 225.** A protocol that allows a user to log on to a remote computer which is also known as remote login is.....
A. FTP B. Telnet
C. HTTP D. None
- 226.** A set of rules that enables a user to log on to another computer and transfer information between it & his/ her computer.
A. HTTP B. FTP
C. WWW D. None
- 227.** PSTN stands for
A. Public Switched Transformation Network

- B. Public Switched Telephone Network
C. Public Serviced Telnet Network
D. None

228. Home Page is also known as

- A. Index Page B. Front Page
C. Back Page D. None

229. GPRS stands for

- A. Global Packet Radio Service
B. Global Positioning Radio Service
C. General Packet Radio Service
D. None

230. GSM stands for

- A. Global System for Mobile
B. Global Service for Mobile
C. Global System for Mobile communication
D. None

231. TCP stands for

- A. Transmission Control Protocol
B. Telnet Control Protocol
C. Transmission Channel Protocol
D. None

232. Proprietary Software is also called as

- A. Closed Source Software
B. Open Source Software
C. Commercial Software
D. None

233. A product that is owned exclusively by a single company that can only function properly, if it is used with other products owned by the same company?

- A. Proprietary Software
B. Public Domain Software
C. Commercial Software
D. None

234. Which of the following activity can be termed as software piracy?

- A. Soft loading B. Counterfeiting
C. Renting D. All of these

235. Linux is a type of Software

- A. Open Source B. Public Domain
C. Commercial D. None

236. A coding language that is compatible with windows servers which is used for increased functionality on a website or to work with a database

- A. HTML B. ASP
C. XML D. None

237. A code that represents English characters as numbers and ranging from 0 to 127.

- A. ASCII B. EBCDIC
C. BCD D. All of above

238. An email feature, which is used to send a copy of an email to one or many other people at the same time that you are sending it to the main recipient/s is called

- A. CC B. BCC
C. To D. None

239. An email feature which is used to send someone a BCC email, their email address will not show in the "to" field

- A. CC B. BCC
C. CC & BCC D. None

240. GUI stands for

- A. Graphic Uninstall/Install
B. Graphical User Interface
C. General Utility Interface
D. None

241. A..... is a design tool that graphically shows the logic in a solution algorithm.

- A. Hierarchy Chart B. Flow Chart
C. Structure Chart D. None

242. Programs designed to perform specific tasks related to managing computer resources are called

- A. System Software B. Utility Software
C. Application Software D. None

243. A contains buttons & menus that provide quick access to commonly used commands.

- A. menubar B. toolbar
C. window D. None

244. What is the split – MAC Architecture?

- A. The split-MAC architecture uses MAC addresses to create a forward/filter table and break up collision domains.
B. The split-MAC architecture uses MAC addresses to create a forward/filter table
C. Both A.&B.
D. None

245. Innormal form, all non-key fields of data structure are dependent on the whole key.

- A. First B. Second
C. Third D. None

246. Which of the following are tasks that may be completed when configuring your e-mail client?

- A. Provide the IP address of your ISP's mail server
B. Provide the name of your e-mail account
C. All of these
D. None of these

247. A pixel is a.....

- A. picture element or dot on a screen
B. point of ink on a laser printed page
C. point of ink on an ink jet printed page
D. None

248. Expansion cards are inserted into

- A. CPU B. Slots
C. Peripheral devices D. None

249..... is a communication technology used by some incoming mail servers.

- A. TCP B. POP3
C. FTP D. None

250. Which of the following format for storing & backing up computer data on tape that evolved from Digital Audio Tape (DAT) technology?

- A. Data Aggregation B. Digital Data Storage
C. Virtual Tape System D. None

251. The two basic parts of URLs are

- A. TCP & IP B. the protocol & the domain name
C. TCP & FTP D. None

252. The storage locations in the internal storage of a CPU is called

- A. reference points B. addresses
C. locations D. None

253. ATM machines run OS

- A. Open Source B. Closed Source
C. embedded D. None

254. The fraudulent practice of sending emails purposing to be from reputable companies in order to induce individuals to reveal personal information (Credit & Debit card details) is called

- A. Hot swapping of devices B. Pharming
C. Phishing D. None

255. NIC stands for

- A. Network Internal Card
B. Network Interconnection Channel
C. Network Interface Card
D. None

256. ---- Is the Virus that overwrites the files or a few parts being replaced?

- A. Virus B. File infectors
C. worm D. None

257. An Internet service that translates domain names to the IP addresses is called

- A. CMS B. ASP
C. DNS D. None

258. A hacker installs malicious code on a personal computer or server. This code then redirects clicks you make on a Web site to another fraudulent Web site without your consent or knowledge. It is known as....

- A. Phishing B. Smishing
C. Pharming D. None

259. The act of using the telephone in an attempt to scam the user into surrendering private information that will be used for identity theft.

- A. Pharming B. Smishing
C. Vishing D. None

260. A type of phishing attack where mobile phone users receive text messages containing a Web site hyperlink is called

- A. Pharming B. Smishing
C. Vishing D. None

261. The creation of Internet Protocol (IP) packets with a forged source IP address, with the purpose of concealing the identity of the sender or impersonating another computing system is called

- A. Pharming B. Spoofing
C. Vishing D. None

262. A malware program that can be used by a black hat cracker to remotely take control of a system for further attacks like spam emails or Denial of Service attacks, without a user's knowledge is called.....

- A. Zombie B. Spoofing
C. Vishing D. None

263. Ethical hackers who use their skill to secure the integrity of computer systems or networks is called

- A. Black Hat B. White Hat
C. Green Hat D. None

264. Spam over instant messenger is called spim while spam over Internet telephony is known as

- A. Malware B. Spit
C. Pharming D. None

265. The unauthorized activities of malicious software is called

- A. Pharming B. Payload
C. Phishing D. None

266. Unauthorized access to restricted systems or resources is referred as

- A. Pharming B. Penetration
C. Phishing D. None

266. Which Key is used for editing a cell?

- A. F2 B. F5
C. F3 D. F4

268. Unauthorized access to information by using a terminal that is already logged on with an authorized ID is called

- A. Piggybacking B. Penetration
C. Phishing D. None

269. Any deliberate damage to operations or equipments is called

- A. Piggybacking B. Sabotage
C. Phishing D. None

270. Sending large numbers of unwanted e-mail messages to a single recipient or to a group of such recipients is termed as

- A. Logic bomb B. Mail bombing
C. Time bomb D. None

271. Malicious modification or destruction of data such as changing information on Web sites is called

- A. Super zapping B. Vandalism
C. Spamming D. None

272. Overwhelming or saturating resources on a target system to cause a reduction of availability to legitimate users is termed as

- A. DistributedDoS attack
B. Denial of Service (DoS) attack
C. Data Diddling
D. None

273. Creating a false identity using someone else's identifying information Computer Questions Thinking of Gov. Job Think IBT

- A. DistributedDoS attack
B. Identity Theft
C. Data Diddling
D. None

274. A program or batch file that waits for a specific time before causing damage is.....

- A. Logic bomb
B. Time bomb
C. Mail bombing
D. None

275. A method for exploiting a vulnerability to take control of a system or otherwise compromise it is termed as.....

- A. Logic bomb
B. Exploit
C. Mail bombing
D. None

276. The most widely used type of database management system is the

- A. Flat databasE.
B. Network databasE.
C. Relational database
D. Hierarchical databasE.

277. IBM 370 belongs to which generation?

- A. 1st generation B. 2nd generation
C. 3rd generation D. 4th generation
E. None of the above

278. Which of the following will connect you to the Internet?

- A. HTTP
B. Internet service provider
C. A network connection
D. None

279. A method in which multiple communication devices are connected to one another efficiently is known as.....

- A. Switching B. Redundancy
C. Capacity D. None

280. What is considered as the 'backbone' of the World Wide Web?

- A. URL B. HTML
C. HTTP D. None

281. MIME stands for

- A. Multipurpose Internet Mail Extension
B. Multicasting Internet Mail Extension
C. Multiple Internet Mail Extension
D. None

282. FPI stands for_____

- A. Figure per inch

- B. Frames per inch
- C. Faults per inch
- D. None

283. The process of analyzing large data sets in search of new, previously undiscovered relationships is known as:

- A. data mining
- B. data marting
- C. data maintenance
- D. data warehousing

284. Collection of interrelated data and set of program to access them is called

- A. Database
- B. Database Management System
- C. Data Structure
- D. data warehousing

285. A repository of data that is designed to serve a particular community of knowledge workers is called

- A. datamart
- B. data maintenance
- C. data warehousing
- D. None

286. Keys that are used in combination with some other key, they have been programmed to perform certain tasks is called

- A. Function keys
- B. Alphanumeric keys
- C. Modifier keys(Alt, Ctrl)
- D. None

287. Which is used to connect a computer to the cabling used in LAN?

- A. Network Interface Card
- B. Router
- C. Modem
- D. None

288. A device that regenerates the signal transmitted on a cable in a network is called

- A. Repeater
- B. Router
- C. Bridge
- D. None

289. A networking device that is used to receive signals from one Computer & transmit them on to other computers in a network is called.....

- A. Repeater
- B. Hub
- C. Bridge
- D. None

290. An intelligent Hub that has the ability to determine the destination of a packet sent across the network is called.....

- A. Repeater
- B. Switch
- C. Bridge
- D. None

291. A most Sophisticated relay device used in a network that can be used to interconnect systems with different protocols, formatting languages and architecture is called.....

- A. Gateway
- B. Switch
- C. Bridge
- D. None

292. CSMA/CD stands for

- A. Carrier Sense Multiple Access with Correction Detection
- B. Code Sense Multiple Access with Collision Detection
- C. Carrier Sense Multiple Access with Collision Detection
- D. None

293. A.....is required at each end to absorb the signal so that it does not reflect back across the bus.

- A. gateway
- B. terminator
- C. bridge
- D. None

294. Bus Topologies can be classified into two types. It includes

- A. Regular Bus
- B. Local Bus
- C. Both A.&B.
- D. None

295. A list of rules for transferring data over a network is called?

- A. Protocol
- B. Program code
- C. Rules
- D. None

296. Star topologies are normally implemented using a

- A. Unshielded Twisted Pair cable
- B. Twisted Pair cable
- C. Fiber Optic Cable
- D. None

297. A set of stations connected serially by cable is known as

- A. Star topology
- B. Bus topology
- C. Ring topology
- D. None

298. OSI stands for

- A. Open Systems Interconnection
- B. Open Source Interconnection
- C. Open Service Interconnection
- D. None

299. Layer which deals with the transportation of binary data and defines cable & electrical specifications is known as.....

- A. Data Link Layer
- B. Physical Layer
- C. Session Layer
- D. None

300. IDRP stands for

- A. ICMP Repeater- Discovery Protocol
- B. ICMP Router- Discovery Protocol
- C. IDRP Router- Discovery Protocol
- D. None

301. RSS Stands for

- A. Rich Site Summary
- B. Really Simple Syndication
- C. A. or B.
- D. None

302. What is the full form of UDP?

- A. Upper Divisional Protocol
- B. User Datagram Protocol
- C. Under Divisional Protocol
- D. None

303. An Interface refers to a specification by which programs can communicate with a web server is called

- A. Graphical User Interface (GUI)
- B. Musical Instrument Digital Interface (MIDI)
- C. Common Gateway Interface (CGI)
- D. None

304. VoIP stands for

- A. Video Over Internet Protocol
- B. Voice Over Internet Protocol
- C. Voice On Internet Protocol
- D. None

305. The two application protocols most commonly associated with

- A. Network File System (NFS)
- B. Common Internet File System (CIFS)
- C. Both A.&B.
- D. None

306. An attacker outside your network pretends to be a part of your network or legal terminal is called...

- A. Password Attacks
- B. IP Spoofing
- C. Identity Theft
- D. None

307. What is Real Time Operating System (RTOS)?

- A. More than one processes can be executed concurrently.
- B. Processing is done with a time constraint
- C. A type of OS which do not interact with a computer directly.
- D. An OS which use multiple central processors to serve multiple real time applications.

308. What is Batch Processing Operating System (RTOS)?

- A. More than one processes can be executed concurrently.
- B. Processing is done with a time constraint
- C. A type of OS which do not interact with a computer directly.

D. An OS which use multiple central processors to serve multiple real time applications.

309. What is Distributed Operating System (RTOS)?

- A. More than one processes can be executed concurrently.
- B. Processing is done with a time constraint
- C. A type of OS which do not interact with a computer directly.
- D. An OS which uses multiple central processors to serve multiple real time applications.

310. Core of the OS which supports the process by dividing a path to peripheral devices?

- A. Kernel
- B. Shell
- C. Fork
- D. None

311. The program which interprets commands given by the user?

- A. Kernel
- B. Shell
- C. Fork
- D. None

312. A system call of OS which is used to create a new process is known as?

- A. Kernel
- B. Shell
- C. Fork
- D. None

313. A process which is not executing due to any waiting event is called?

- A. Kernel
- B. Shell
- C. Deadlock
- D. None

314. Which provides an interface between process & OS?

- A. Kernel
- B. System Calls
- C. Deadlock
- D. None

315. User Interface can be divided into two types. They are

- A. Graphical User Interface
- B. Character User Interface
- C. A.&B.
- D. None

316. which one of the following is an MS-DOS external command?

- A. COPY
- B. FORMAT
- C. DIR
- D. None

317. In Windows ME, what does ME stands for?

- A. Micro-Expert
- B. Millennium-Edition
- C. Multi-Expert
- D. None

318. In OSI architecture, the routing algorithm is performed by

- (A) Data Link Layer
- (B) Network layer
- (C) Physical layer
- (D) Transport layer
- (E) None of these

319. There are a total of.....actions button in PowerPoint.

- A. 12
- B. 15
- C. 18
- D. None

320. Attributes can be defined for

- A. pages
- B. entity
- C. macro
- D. None

321. What is the default size of the data type in MS Access?

- A. 50
- B. 60
- C. 70
- D. None

322...... means that the data contained in a database is accurate & reliable

- A. Data redundancy
- B. Data integrity
- C. Data consistency
- D. None

323. The smallest unit of information about a record is called a.....

- A. cell
- B. field
- C. record
- D. NonE.

324. Which combines efficient implementation techniques that enable them to be used in extremely large database?

- A. Data Mining

- B. Data Manipulation
- C. Data reliability
- D. NonE.

325. A program that generally has more user-friendly interface than a DBMS is called a

- A. back end
- B. front end
- C. form
- D. NonE.

326. A collection of conceptual tools for describing data, relationships, semantics & constraints is referred as....

- A. data model
- B. ER model
- C. DBMS
- D. NonE.

327. Dr. E.F.Codd represented..... rules that a database must obey if it has to be considered truly relational.

- A. 4 b
- B. 8
- C. 12
- D. NonE.

328...... is one reason for problems of data integrity

- A. Data availability constraints
- B. Data redundancy
- C. Data reliability
- D. NonE.

329.provides total solutions to reduce data redundancy, inconsistency, dependence & unauthorized access of data.

- A. Table
- B. Protection password
- C. Data reliability
- D. None.

330...... are distinct items that don't have much meaning to you in a given answer

- A. Fields
- B. Data
- C. Queries
- D. None.

331. A collection of related files is called.....

- A. field
- B. record
- C. database
- D. None.

332. A logical schema

- A. is the entire database
- B. is a standard way of organizing information into accessible part
- C.A.&B.
- D. NonE.

333. To locate a data item for storage is

- A. field
- B. fetch
- C. feed
- D. NonE.

334. Find out the perfect pair of input devices?

- A. keyboard, touch screen, mouse
- B. Mouse, Fax Machine, Light Pen
- C. Light Pen, Keyboard, Joysticks.
- D. Keyboard, Mouse, Digital Camera
- C. None of these.

335. Which one is true according to speed?

- A. LAN>WAM>MAN
- B. WAN>MAN>LAN
- C. LAN>MAN>WAN
- D. MAN<LAN<WAN
- E. None

336. An E-R diagram is a graphic method of presenting

- A. entity classes & their relationships
- B. primary keys & their relationships
- C. primary keys & their relationships to instances
- D. NonE.

337. An entity set that does not have sufficient attributes to form a primary key, is a.....

- A. primary entity set
- B. weak entity set
- C. simple entity set
- D. NonE.

338. A computer checks of username & password for a match before granting access.

- A. website
- B. network
- C. database
- D. None.

339. is a primary key of one file that also appears in another file?

- A. Physical key
- B. Foreign key
- C. Logical key
- D. None.

340. Key to represent relationship between tables is called

- A. Physical key
- B. Foreign key
- C. Logical key
- D. NonE.

341. In a relational database, a data structure that organizes the information about a single topic into rows & columns, is....

- A. block
- B. record
- C. tuple
- D. table

342. Hub is associated with..... network

- A. bus
- B. ring

C. star

D. mesh

343. Multiplexing involves.....path and.... channel

- A. single path & multiple channel
- B. Single path & single channel
- C. multiple path & multiple channel
- D. mesh

344. P2P is a.....application architecture

- A. distributed
- B. client/server
- C. 1-tier
- D. None

345. In OSI architecture, the routing is performed by

- A. network layer
- B. data link layer
- C. transport layer
- D. None

346. Which of the following is considered a broad band communication channel?

- A. Coaxial Cable
- B. Fiber Optics Cable
- C. Microwave Circuits
- D. All of these

347. How many bits are there in the Ethernet address?

- A. 48 bits
- B. 64 bits
- C. 16 bits
- D. None

348. Ethernet, token ring and token bus are types of

- A. LAN
- B. WAN
- C. MAN
- D. None

349. Which of the following items is not used in LANs?

- A. Interface card
- B. cable
- C. computer
- D. Modem

350. which is the name of the network topology in which there are bidirectional links between each possible nodes?

- A. Mesh
- B. Ring
- C. Bus
- D. None

351. An alternate name for the completely interconnected network topology is
A. Mesh
B. Ring
C. Bus
D. None
352. Telnet is.....based computer protocol
A. sound
B. image
C. text
D. None
353. through.....an administrator or another user can access someone else's computer remotely.
A. Web server
B. Web application
C. telnet
D. None
354. How many ways you can save a document?
A. 5
B. 4
C. 3
D. None
355. The maximum zoom % in MS Power Point is.....
A. 400
B. 100
C. 200
D. None
356. In Excel, charts are created using which option?
A. Pie Chart
B. Chart Wizard
C. Bar Chart
D. None
357. In order to include picture data type must be?
A. OLE
B. hyperlink
C. A. or B.
D. None
358. A..... is the term used when a search engine returns a web page that matches search criteria
A. blog
B. hit
C. link
D. None
359. Which is required to create an html document?
A. Internet
B. text editor
C. Browser
D. None
360. Which of the following will be used if a sender of e-mail wants to bold, italics etc, the text message?
A. Rich text
B. Rich signature
C. Reach format
D. None
361. Which stores information about the user's web activity?
A. Spam
B. Cookie
C. Cache
D. None
362. Each IP packet must contain
A. Source address
B. destination address
C. A.&B.
D. None
363. Vendor-created program modifications are called—
A. patches
B. antiviruses
C. holes
D. None
364. If your computer rebooting itself then it is likely that
A. It has a virus
B. It does not have enough memory
C. There has been a power surge
D. None
365. The of a Threat measures its potential impact on a System
A. vulnerabilities
B. degree of harm
C. susceptibility
D. None
366. A digital signature is
A. scanned signature
B. encrypting information
C. signature in binary form
D. None
367. A firewall operated by
A. the pre-purchase phase
B. isolating intranet from extranet
C. screening packets to/from the network & provide controllable filtering of network traffic.
D. None

368. Which one of the following is a cryptographic protocol used to secure http session?

- A. Transport Layer Security
- B. Explicit Congestion Notification
- C. Resource Reservation Notification (RRN)
- D. None

369. Which of the following inputs a computer's memory, but unlike a virus, it does not replicate itself?

- A. Trojan Horse
- B. Logic bomb
- C. Firewall
- D. None

370. Which one of the following is a key function of firewall?

- A. Monitoring
- B. deleting
- C. moving
- D. None

371. The load instruction is mostly used to designate a transfer from memory to a processor register known as

- A. Program counter
- B. instruction register
- C. accumulator
- D. None

372. The most frequently used instructions of a computer program are likely to be fetched from

- A. cache
- B. cookie
- C. main memory
- D. None

373. Arithmetic Logic Unit (ALU) and control sections have special purpose locations called

- A. secondary memory
- B. registers
- C. accumulator
- D. None

374. Who was the Inventors of Computer Chip (IC)

- A. Jack Kilby
- B. Robert Noyce
- C. Jack Kilby and Robert Noyce
- D. John McCarthy
- E. Martin Cooper

375. Gigabyte represents approximately _____ memory locations.

- A. one billion
- B. one million
- C. one trillion
- D. two million
- E. none of the above

376. In a worksheet lines between cells are called as _____.

- A. Cross lines
- B. Gridlines
- C. Parallel lines
- D. Adjacent
- E. None of these

377. EDVAC stands for _____.

- A. Electronic Disc Variable Automatic Computer
- B. Electronic Discrete Variable Automatically Computer
- C. Electronic Discrete Variable Automatic Computer
- D. Electronic Discrete Versatile Automatic Computer

378. Binary equivalent to 87 is:

- A. 1010111
- B. 1101111
- C. 1011111
- D. 10111111
- E. None of these

379. Stack is the _____ structure.

- A. Last in first out (LIFO)
- B. First in First out (FIFO)
- C. First in Last out (FILO)
- D. First come First served (FCFS)
- E. None of these

380. Which layer is reasonable for the user interface?

- A.Physical Layer B.Application Layer
- C.Data Link Layer D.Network Layer
- E.Session Layer

381.A _____ network has a central (hub) computer that is responsible for managing the network

- A.star B.ring
- C.Bus D.Mesh
- E.None of the above

382. IPv6 works on _____ bit.

- A.32 bit B.64 bit
- C.16 bit D.128 bit
- E.256 bit

383..How many maximum columns insert in MS word table?

- A.32 B.61
- C.63 D.65
- E.67

384. AND gate output with three inputs, A, B, and C, is HIGH when _____.

- A. A = 1, B = 1, C = 0
- B. A = 0, B = 0, C = 0
- C. A = 1, B = 1, C = 1
- D. A = 1, B = 0, C = 1
- E. A = 0, B = 1, C = 1

385. Which one of the following image represents a NOR gate?

A.



B.



C.

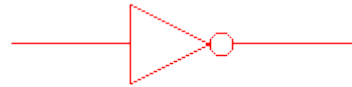

D.

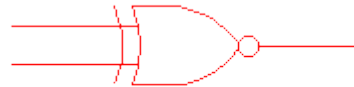

386. What will be the one's complement of (10101)

- A.01010 B.11111
- C.00010 D.11000
- E.10100

387. What will be the two's complement of (10101)

- A.01010 B.11111
- C.01011 D.11000
- E.10100

388. Which of the following represent Associative Law?

- A.(A.B).C = A.(B.C)
- B.(A.B).C = A.C + A.B
- C.A.B=B.A
- D.A.(B.C) = A.B + A.C
- E.None of the above

389. How many Keywords available in 'C' Language?

- A.25 B.23
- C.32 D.36
- E.39

390. Result of this given the image is equal to -----

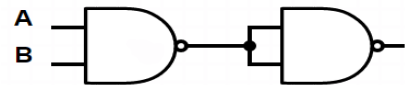

- A.AND Gate B.OR Gate
- C.NOT Gate D.NOR Gate
- E.None of the above

391. Convert $(577)_8 = (?)_{16}$

- A.17F B.16E
- C.17E D.15D
- E.16F

392. Convert $(111111110010)_2 = (?)_{16}$

Computer Capsule – IBPS PO, RRB & Clerk Mains Exam

A. $(EE2)_{16}$

B. $(FF2)_{16}$

C. $(2FE)_{16}$

D. $(FD2)_{16}$

E. None of these

393. Convert $(8B3F)_{16} = (?)_2$

A. 35647

B. 011010

C. 1011001111100011

D. 1000101100111111

E. 1001111110011000

394. Father of 'C' programming language _____.

A. Dennis Ritchie

B. Prof Jhon Kemeny

C. Thomas Kurtz

D. Bill Gates

E. None

395. Which of the following is not a method of accessing the web?

A. modem

B. ISDN

C. DSL

D. CPU

E. None of these

396. Yahoo (www.yahoo.com) is a _____.

A. Website for Consumers

B. Portal

C. Organization that allocates web addresses

D. Super Computer

E. None of these.

397. Time during which a job is processed by the computer is ____.

A. Execution Time

B. Delay Time

C. Real Time

D. Waiting Time

E. None of these

398. Internet Explorer is a _____.

A. Web Browser

B. Graphing Package

C. News Reader

D. Any person browsing the net

E. None of these

399. 1st microprocessor in the world _____.

A. 8085

B. 8086

C. I-4004

D. 8286

E. None of these

400. Which memory is used to store the data until the light is on _____?

A. RAM

B. ROM

C. PROM

D. CACHE

E. None of these

ANSWER KEY

1 (C)	2 (A)	3 E	4 (D)	5 (C)	6 (A)	7 (A)	8 (D)	9 (E)	10 (B)
11 (B)	12 (C)	13 (A)	14 (C)	15 (C)	16 (B)	17 (B)	18 (B)	19 (B)	20 (D)
21 (C)	22 (B)	23 (A)	24 (A)	25 (D)	26 (C)	27 (C)	28 (D)	29 (C)	30 E
31 (C)	32 (C)	33 (D)	34 (B)	35 (C)	36 (B)	37 (D)	38 (C)	39 (A)	40 (C)
41 (C)	42 (B)	43 (A)	44 (C)	45 (C)	46 (B)	47 (D)	48 (A)	49 (D)	50 (D)
51 (A)	52 (C)	53 (D)	54 (B)	55 (B)	56 (D)	57 (D)	58 (C)	59 (D)	60 (C)
61 (A)	62 (B)	63 (C)	64 (A)	65 (B)	66 (A)	67 (D)	68 (C)	69 (B)	70 (D)
71 (C)	72 (A)	73 (A)	74 (C)	75 (A)	76 (B)	77 (A)	78 (B)	79 (B)	80 (A)
81 (E)	82 (D)	83 (A)	84 (C)	85 (A)	86 (B)	87 (A)	88 (A)	89 (D)	90 (C)
91 (A)	92 (B)	93 (B)	94 (C)	95 (C)	96 (D)	97 (A)	98 (E)	99 (B)	100 (B)
101 (A)	102 (C)	103 (C)	104 (B)	105 (A)	106 (B)	107 (B)	108 (A)	109 (C)	110 (B)
111(B)	112 (C)	113 (A)	114 (C)	115 (A)	116 (B)	117 (A)	118 (C)	119 (C)	120 (A)
121 (C)	122 (A)	123 (C)	124 (C)	125 (D)	126 (D)	127 (A)	128 (C)	129 (C)	130 (A)
131 (C)	132 (B)	133 (C)	134 (C)	135 (D)	136 (A)	137 (A)	138 (D)	139 (B)	140 (A)
141 (D)	142 (B)	143 (A)	144 (D)	145 (D)	146 (B)	147 (D)	148 (C)	149 (D)	150 (A)
151 (A)	152 (A)	153 (B)	154 (D)	155 (D)	156 (C)	157 (A)	158 (D)	159 (C)	160 (C)
161 (D)	162 (C)	163 (C)	164 (D)	165 (A)	166 (B)	167 (D)	168 (D)	169 (C)	170 (C)
171 (C)	172 (A)	173 (D)	174 (C)	175 (A)	176 (B)	177 (C)	178 (A)	179 (A)	180 (B)
181 (B)	182 (A)	183 (D)	184 (B)	185 (A)	186 (D)	187 (B)	188 (C)	189 (A)	190 (B)
191 (B)	192 (C)	193 (C)	194 (B)	195 (B)	196 (A)	197 (D)	198 (C)	199 (D)	200 (B)
201 (C)	202 (A)	203 (C)	204 (C)	205 (A)	206 (A)	207 (A)	208 (C)	209 (B)	210 (A)
211 (C)	212 (B)	213 (A)	214 (C)	215 (B)	216 (B)	217 (C)	218 (A)	219 (D)	220 (A)
221 (A)	222 (A)	223 (A)	224 (A)	225 (B)	226 (B)	227 (B)	228 (A)	229 (C)	230 (C)
231 (A)	232 (A)	233 (A)	234 (D)	235 (A)	236 (B)	237 (A)	238 (A)	239 (B)	240 (B)
241 (B)	242 (B)	243 (B)	244 (A)	245 (B)	246 (A)	247 (A)	248 (B)	249 (B)	250 (B)
251 (B)	252 (B)	253 (C)	254 (C)	255 (C)	256 (B)	257 (C)	258 (C)	259 (C)	260 (B)
261 (B)	262 (A)	263 (B)	264 (B)	265 (B)	266 (B)	267 ()	268 (A)	269 (B)	270 (B)
271 (B)	272 (B)	273 (B)	274 (B)	275 (B)	276 (C)	277 (C)	278 (B)	279 (A)	280 (C)
281 (A)	282 (B)	283 (A)	284 (A)	285 (A)	286 (C)	287 (A)	288 (A)	289 (B)	290 (B)
291 (A)	292 (C)	293 (B)	294 (C)	295 (A)	296 (A)	297 (C)	298 (A)	299 (B)	300 (B)
301 (C)	302 (B)	303 (C)	304 (B)	305 (C)	306 (C)	307 (B)	308 (C)	309 (D)	310 (A)
311 (B)	312 (C)	313 (C)	314 (B)	315 (C)	316 (B)	317 (B)	318 (B)	319 (A)	320 (B)
321 (A)	322 (B)	323 (B)	324 (A)	325 (C)	326 (A)	327 (C)	328 (A)	329 (B)	330 (B)

331 (B)	332 (A)	333 (B)	334 (C)	335 (C)	336 (A)	337 (C)	338 (B)	339 (B)	340 (B)
341 (D)	342 (C)	343 (A)	344 (B)	345 (A)	346 (D)	347 (A)	348 (A)	349 (D)	350 (A)
351 (A)	352 (C)	353 (C)	354 (C)	355 (A)	356 (B)	357 (A)	358 (B)	359 (B)	360 (A)
361 (B)	362 (C)	363 (A)	364 (A)	365 (B)	366 (B)	367 (C)	368 (A)	369 (B)	370 (A)
371 (C)	372 (A)	373 (B)	374 (C)	375 (A)	376 (B)	377 (B)	378 (A)	379 (A)	380 (B)
381 (A)	382 (D)	383 (C)	384 (C)	385 (B)	386 (A)	387 (C)	388 (A)	389 (C)	390 (A)
391 (A)	392 (B)	393 (D)	394 (A)	395 (D)	396 (A)	397 (A)	398 (A)	399 (C)	400 (A)